

# Axygen® Brand Equipment Product Selection Guide

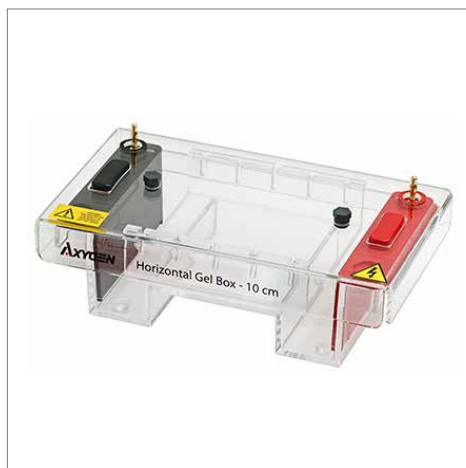
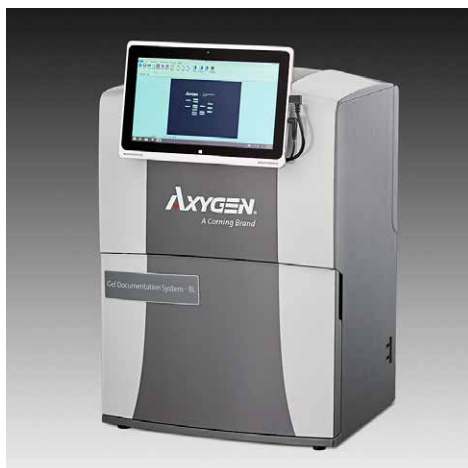

## Contents

Axygen® Gel Documentation Systems .....	2
Axygen Horizontal Gel Boxes .....	5
Axygen MaxyGene II Thermal Cyclers .....	8
Axygen PlateMax Semi-automatic Plate Sealers .....	10
Axygen Axyspin Refrigerated Microcentrifuges .....	12
Axygen Axyspin Mini Plate Spinner Centrifuges .....	13
Axygen Axypet® Pro Single- and Multi-channel Pipettors .....	14
Axygen Axypet Single and Multi-channel Pipettors .....	15
Axygen Axypet 16-channel Pipettors .....	17
Axygen MotoPet® Pipet Controller .....	18

For additional product or technical information, visit [fishersci.com](http://fishersci.com), call 1.800.766.7000, or contact your Fisher Scientific™ representative.

# Axygen® Gel Documentation Systems



Axygen Gel Documentation System-BL



Axygen Gel Documentation System

Axygen Gel Documentation systems easily capture publication quality, 16 bit TIFF images. The systems are quick to set up and have an intuitive user interface for image capture, annotation, and contrast adjustment. Images are easily saved and opened in common gel analysis software for more detailed analysis.

- ▶ Auto exposure—you never have to manually manipulate the camera
- ▶ Ready-to-use—just connect the computer\* and load the software
- ▶ Long-life dual wavelength transilluminators
- ▶ Exceptionally high resolution (5.4 MP) camera
- ▶ The cabinet is compact with an ultra-violet (UV) cut-off switch to prevent exposure to UV light if the cabinet door is opened while the UV light is on.

## Choose from Two Axygen Gel Documentation Systems

The **Axygen Gel Documentation System** is an ideal system for labs that want good value without compromising ease of use or image quality. It includes a dual-wavelength transilluminator, 5.4 MP image resolution camera, and image acquisition software (PC not included).

The **Axygen Gel Documentation System-BL** has all the features of the standard Axygen Gel Documentation system, as well as built-in blue lights and a built-in Microsoft® Windows® tablet. The blue lights are designed for use with EtBr replacement dyes to prevent damage to DNA that will be excised for subsequent analysis.

## Features

- ▶ Darkroom tab lets you select from UV 302, UV 365, Epi White, or Epi Blue (BL system only) light sources, as well as an optional Trans White light illumination tray.
- ▶ Auto Exposure tool calculates the optimal exposure time with just a single click. You can also use the Slider tool to manually adjust the exposure time and view an updated live image.
- ▶ Select ROI tool allows you to select a region of interest. The Auto Exposure calculations are only based on the selected region. This feature is especially useful for gels that have either intense or faint bands.
- ▶ Band Excision tool allows you to temporarily override the safety precautions in the system to view the gel with the lights on.\*\*
- ▶ Imaging tools include crop, rotate, resize, contrast, saturation, and zoom. Annotation tools include a variety of text and drawing tools. Finished images can be saved, printed, emailed, or exported for further analysis.
- ▶ Transillumination bulbs last for 30,000 hours—which equals over 3.5 years if the bulbs were in continuous use.

\*BL model includes tablet computer with software already included.

\*\*Always wear protective eyewear when working with UV light.

**Everything You Expect From a High Resolution Gel Doc System—Except the High Price.**

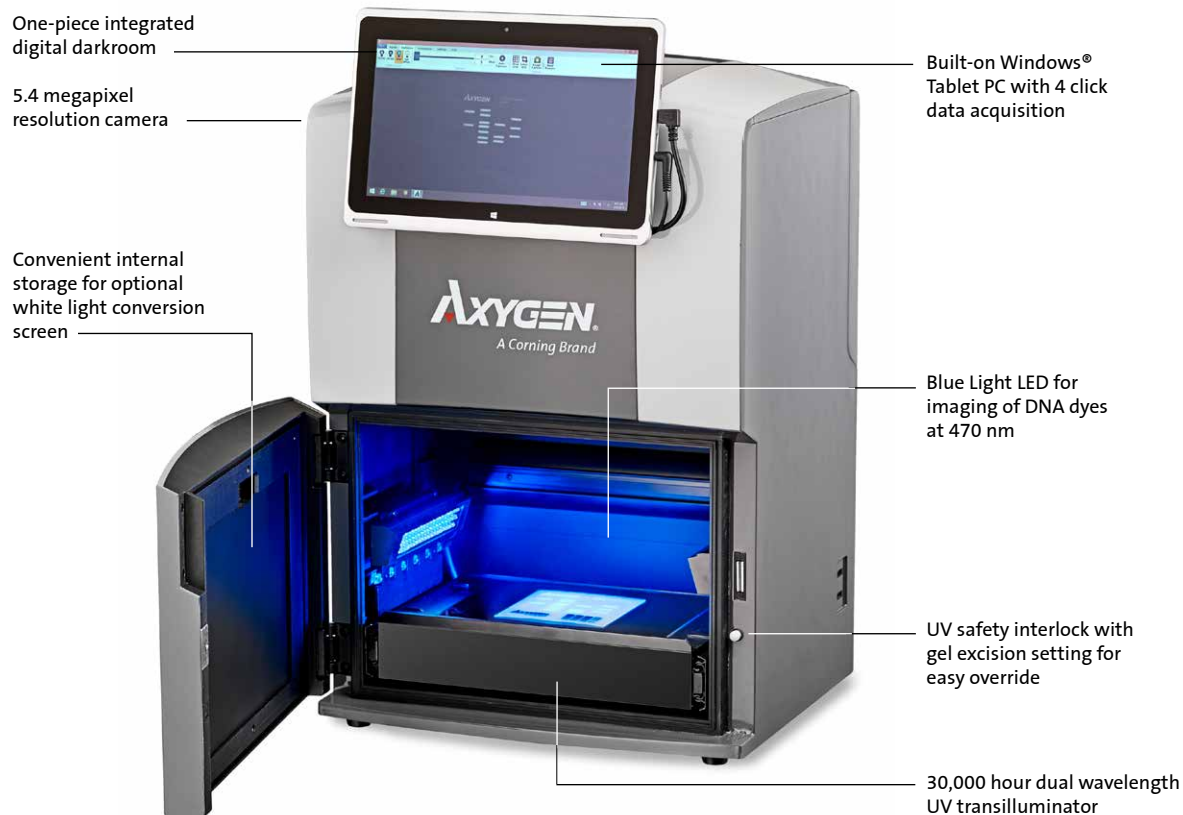

**Axygen Gel Documentation System-BL**

**Specifications**

Axygen® System	Gel Documentation System	Gel Documentation System-BL
Camera	5.4 MP image resolution	5.4 MP image resolution
Lens	f1.8	f1.8
Light Sources	<ul style="list-style-type: none"> <li>▶ Epi White</li> <li>▶ Dual wavelength transillumination at 302 nm and 365 nm</li> </ul>	<ul style="list-style-type: none"> <li>▶ Epi White</li> <li>▶ Dual wavelength transillumination at 302 nm and 365 nm</li> <li>▶ Epi Blue</li> </ul>
Trans White Light Illumination Tray	Optional	Optional
Field of View	15 cm x 20 cm	15 cm x 20 cm
Cabinet	<ul style="list-style-type: none"> <li>▶ Door sensor to prevent accidental exposure to UV; automatically shuts off UV light when door is open</li> <li>▶ Safety override, enabling band cutting on the UV transilluminator with automatic turn off after 5 minutes</li> </ul>	<ul style="list-style-type: none"> <li>▶ Door sensor to prevent accidental exposure to UV; automatically shuts off UV light when door is open</li> <li>▶ Safety override, enabling band cutting on the UV transilluminator with automatic turn off after 5 minutes</li> </ul>
Emission Filter	590 nm	590 nm
3-position Filter Slider	No	Yes
Certifications	CE, cTUVus	CE, cTUVus
Product Footprint	12" x 15" (30.48 cm x 38.1 cm)	12" x 15" (30.48 x 38.1 cm)
Computer	<ul style="list-style-type: none"> <li>▶ Operating system: Microsoft® Windows® 7 or higher</li> <li>▶ Minimum hardware requirements: Intel® processor, 1.4 GHz processor speed, 2 GB RAM, 16 GB free hard disk space, 2 USBs</li> </ul>	<ul style="list-style-type: none"> <li>▶ Tablet included: Windows 8 tablet computer enables compatibility with existing networks, as well as easy setup (also Windows 10 compatible)</li> <li>▶ Bluetooth and wireless compatible, or USB to LAN compatible</li> <li>▶ 10.1" touch screen</li> <li>▶ 2 GB of storage for short-term data saving</li> </ul>

## Ordering Information

### Axygen® Gel Documentation Systems and Accessories

Fisher Scientific Cat. No.	Corning Cat. No.	Description	Qty/Pk	Qty/Cs
14-224-009	GD-1000	Gel Documentation System	1	1
14-224-010	GDBL-1000	Gel Documentation System-BL	1	1
14-224-011	GD-BLCS	Gel Documentation System blue light conversion screen for GD-1000	1	1
14-224-012	GD-WLCS	Gel Documentation System white light conversion screen for GD-1000 and GDBL-1000	1	1
14-224-013	GD-GCT	Gel carrying tray for GD-1000 and GDBL-1000	1	1
14-224-014	GD-PRT	Thermal printer	1	1
14-224-015	GD-PAPER	Thermal printer paper	1	1
14-224-016	GD-1D	1 user license of Total Lab 1D (more user licenses available upon request)	1	1
14-224-017	GD-1DN	1 user Network license of Total Lab 1D (more user licenses available upon request)	1	1
14-224-018	GDBL-BLUE	Optional blue filter (497 nm)	1	1
14-224-019	GDBL-GREEN	Optional green filter (572 nm)	1	1
14-224-021	GD-GCS	UV transmitting tray that protects UV transilluminator when cutting out bands	1	1
14-224-022	GD-OG	Orange glasses ideal for reducing background when cutting out bands with blue light	1	1
14-224-023	GD-USBS	USB hub	1	1
14-224-024	GD-USBMK	USB mouse and keyboard	1	1

### Related Products

#### Axygen Gel Cutting Pipet Tips

Fisher Scientific Cat. No.	Corning Cat. No.	Description	Qty/Pk	Qty/Cs
14-222-805	TGL-1165-R	1.1 mm x 6.5 mm gel cutting pipet tips	480	2,400
14-222-804	TGL-1165	1.1 mm x 6.5 mm gel cutting pipet tips	250	2,500
14-222-803	TGL-1140-R	1.1 mm x 4 mm gel cutting pipet tips	480	2,400
14-222-802	TGL-1140	1.1 mm x 4 mm gel cutting pipet tips	250	2,500

#### Axygen Gel Loading Pipet Tips

14-222-801	TGL-10FT-17-R	0.17 mm, 10 µL racked flat gel loading pipet tips	400	400
10-505-540	TGL-200FT-37-R-S	0.37 mm, 200 µL racked flat gel loading pipet tips, sterile	400	400
14-222-807	TGL-200FT-37-R	0.37 mm, 200 µL racked flat gel loading pipet tips	400	400
14-222-810	TGL-200RD-57-R-S	0.57 mm, 200 µL racked round gel loading tips, sterile	400	400
14-222-809	TGL-200RD-57-R	0.57 mm, 200 µL racked round gel loading tips	400	400

#### Axygen DNA Markers

14-223-050	M-DNA-100BP	100 bp DNA ladder	500 µL	500 µL
14-223-051	M-DNA-1KB	1 kb DNA ladder	500 µL	500 µL

#### Axygen Agarose

14-223-081	AGR-LE-100	Agarose LE, low EEO, molecular biology grade, 100 g	1	1
14-223-040	AGR-LE-1001	Agarose LE, low EEO, molecular biology grade, 100 g	10	10
14-223-080	AGR-LE-500	Agarose LE, low EEO, molecular biology grade, 500 g	1	1
14-223-041	AGR-LE-5001	Agarose LE, low EEO, molecular biology grade, 500 g	10	10
14-223-082	AGR-LM-50	Agarose LM, low melting, molecular biology grade, 50 g	1	1
14-223-042	AGR-LM-501	Agarose LM, low melting, molecular biology grade, 50 g	10	10
14-223-083	AGR-LM-100	Agarose LM, low melting, molecular biology grade, 100 g	1	1
14-223-043	AGR-LM-1001	Agarose LM, low melting, molecular biology grade, 100 g	10	10
14-223-084	AGR-MS-50	Agarose MS, PCR screening, molecular biology grade, 50 g	1	1
14-223-044	AGR-MS-501	Agarose MS, PCR screening, molecular biology grade, 50 g	10	10
14-223-085	AGR-MS-100	Agarose MS, PCR screening, molecular biology grade, 100 g	1	1
14-223-045	AGR-MS-1001	Agarose MS, PCR screening, molecular biology grade, 100 g	10	10

#### Corning® Buffers

MT46011CM	46-011-CM	10X TBE Buffer, liquid	6 x 1L	6 x 1L
MT46010CM	46-010-CM	10X TAE Buffer, liquid	6 x 1L	6 x 1L

# Axygen® Horizontal Gel Boxes

Axygen horizontal gel boxes are high quality, full featured units designed for exceptional durability and efficiency. The gel boxes feature leak-free external gel casting, which allows you to cast one gel outside of the box while another gel is running inside. The units are available in four different sizes, and each unit comes with two sizes of gel trays. In addition, they have easy to replace electrodes that are recessed to reduce potential damage. These gel boxes are an excellent value that will provide years of reliable service.

## Features

- ▶ Flexibility – each unit comes with 2 sizes of gel trays to optimize applications.
- ▶ External gel casting to gel box allows for running gels while casting the next one.
- ▶ Ease of use – the Axygen contrast enhancer makes loading gels easier.
- ▶ Rugged injection molding is supported by a 3-year warranty.
- ▶ Larger units come with recirculation ports allowing for buffer exchange.

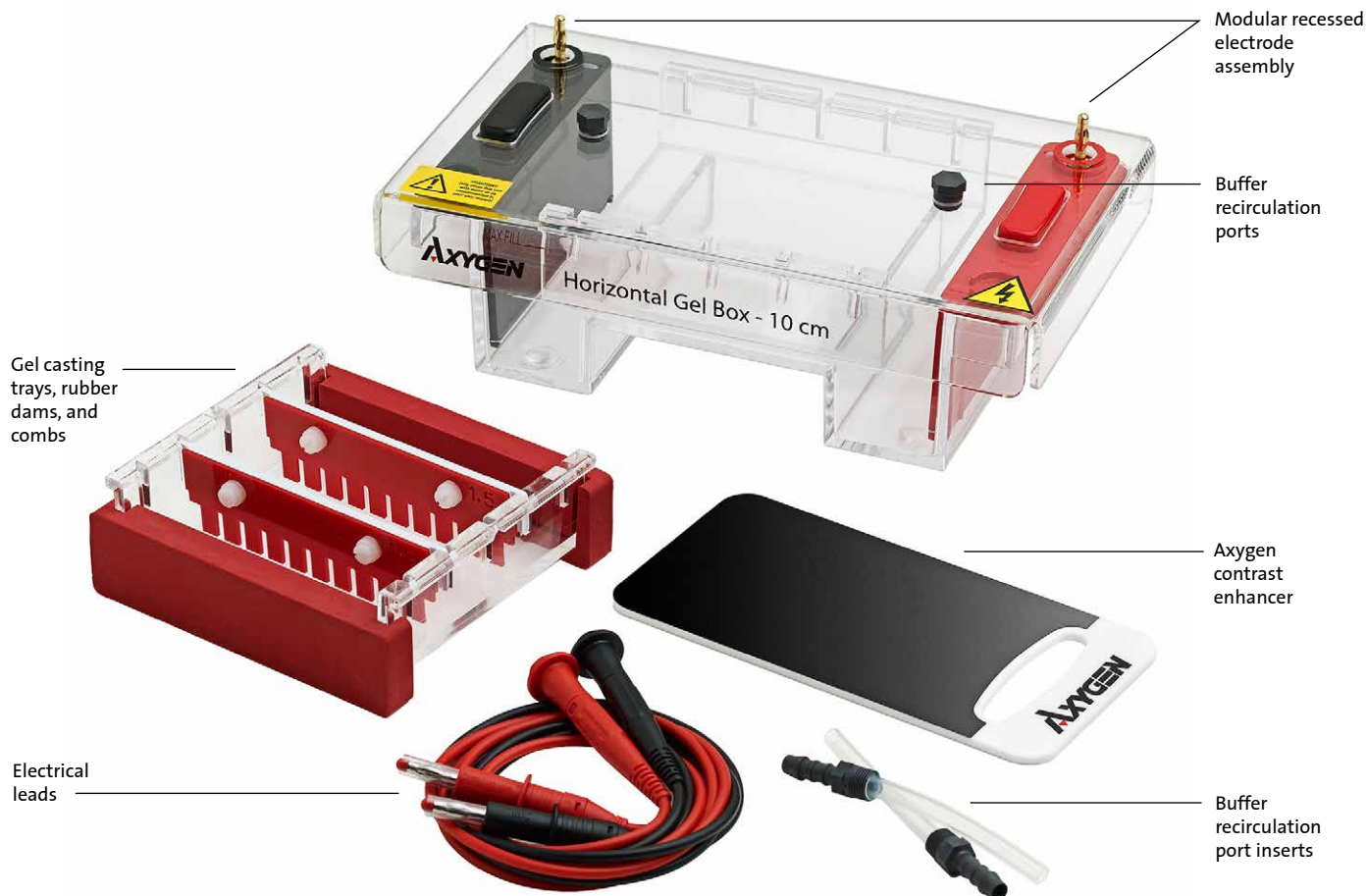

## Axygen® Horizontal Gel Boxes

Four sizes of horizontal tanks. Each comes with 2 sizes of gel trays which allow for external gel casting. Three larger sizes come with recirculation ports for use as needed.

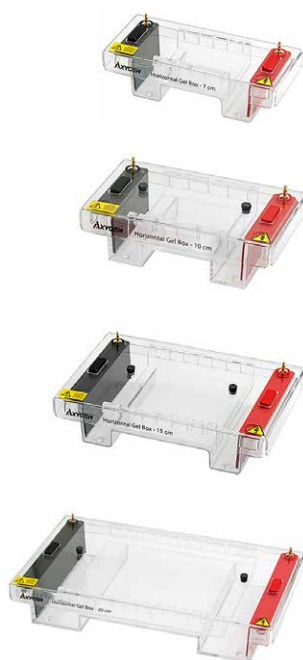

Fisher Scientific Cat. No.	Corning Cat. No.	Description
14-223-900	HGB-7	Tray sizes: 7 x 7 cm, 7 x 10 cm Recirculation ports: No Combs: 2 x 8 well, 1.5 mm thickness
14-223-901	HGB-10	Tray sizes: 10 x 10 cm, 10 x 12 cm Recirculation ports: Yes Combs: 2 x 10 multi-channel compatible well, 1.5 mm thickness
14-223-902	HGB-15	Tray sizes: 15 x 10 cm, 15 x 15 cm Recirculation ports: Yes Combs: 1 x 16 multi-channel compatible well, 1.5 mm thickness 1 x 20 well, 1.5 mm thickness
14-223-903	HGB-20	Tray sizes: 20 x 20 cm, 20 x 25 cm Recirculation ports: Yes Combs: 2 x 20 multi-channel compatible well, 1.5 mm thickness 2 x 40 multi-channel compatible well, 1.5 mm thickness

## Ordering Information

### Combs and Accessories

#### Axygen Horizontal Gel Box, 7 cm (1/case)

Fisher Scientific Cat. No.	Corning Cat. No.	Description
14-223-900	HGB-7	Axygen horizontal gel box, 7 cm
14-223-910	HGB7-5-15	5-well comb for use with 7 cm gel box, 1.5 mm thickness
14-223-911	HGB7-8-075	8-well comb for use with 7 cm gel box, 0.75 mm thickness
14-223-912	HGB7-8-1	8-well comb for use with 7 cm gel box, 1.0 mm thickness
14-223-904	HGB7-10-1	10-well comb for use with 7 cm gel box, 1.0 mm thickness
14-223-905	HGB7-10-15	10-well comb for use with 7 cm gel box, 1.5 mm thickness
14-223-906	HGB7-12MC-1	12-well multi-channel compatible comb for use with 7 cm gel box, 1.0 mm thickness
14-223-907	HGB7-12MC-15	12-well multi-channel compatible comb for use with 7 cm gel box, 1.5 mm thickness
14-223-908	HGB7-16-1	16-well comb for use with 7 cm gel box, 1.0 mm thickness
14-223-909	HGB7-16-15	16-well comb for use with 7 cm gel box, 1.5 mm thickness

#### Axygen Horizontal Gel Box, 10 cm (1/case)

Fisher Scientific Cat. No.	Corning Cat. No.	Description
14-223-901	HGB-10	Axygen horizontal gel box, 10 cm
14-223-926	HGB10-8-1	8-well comb for use with 10 cm gel box, 1.0 mm thickness
14-223-913	HGB10-10MC-1	10-well multi-channel compatible comb for use with 10 cm gel box, 1.0 mm thickness
14-223-914	HGB10-10MC-15	10-well multi-channel compatible comb for use with 10 cm gel box, 1.5 mm thickness
14-223-915	HGB10-12-075	12-well comb for use with 10 cm gel box, 0.75 mm thickness
14-223-916	HGB10-12-1	12-well comb for use with 10 cm gel box, 1.0 mm thickness
14-223-917	HGB10-12-15	12-well comb for use with 10 cm gel box, 1.5 mm thickness
14-223-918	HGB10-16-075	16-well comb for use with 10 cm gel box, 0.75 mm thickness
14-223-919	HGB10-16-1	16-well comb for use with 10 cm gel box, 1.0 mm thickness
14-223-920	HGB10-16-15	16-well comb for use with 10 cm gel box, 1.5 mm thickness
14-223-921	HGB10-16-2	16-well comb for use with 10 cm gel box, 2.0 mm thickness
14-223-922	HGB10-20MC-1	20-well multi-channel compatible comb for use with 10 cm gel box, 1.0 mm thickness
14-223-923	HGB10-20MC-15	20-well multi-channel compatible comb for use with 10 cm gel box, 1.5 mm thickness
14-223-924	HGB10-25-1	25-well comb for use with 10 cm gel box, 1.0 mm thickness
14-223-925	HGB10-25-2	25-well comb for use with 10 cm gel box, 2.0 mm thickness

**Axygen® Horizontal Gel Box, 15 cm (1/case)**

Fisher Scientific Cat. No.	Corning Cat. No.	Description
14-223-902	HGB-15	Axygen horizontal gel box, 15 cm
14-223-951	HGB15-8-15	8-well comb for use with 15 cm gel box, 1.5 mm thickness
14-223-927	HGB15-10-1	10-well comb for use with 15 cm gel box, 1.0 mm thickness
14-223-928	HGB15-10-15	10-well comb for use with 15 cm gel box, 1.5 mm thickness
14-223-929	HGB15-12-1	12-well comb for use with 15 cm gel box, 1.0 mm thickness
14-223-930	HGB15-12-15	12-well comb for use with 15 cm gel box, 1.5 mm thickness
14-223-932	HGB15-14MC-1	14-well multi-channel compatible comb for use with 15 cm gel box, 1.0 mm thickness
14-223-931	HGB15-14MC-15	14-well multi-channel compatible comb for use with 15 cm gel box, 1.5 mm thickness
14-223-933	HGB15-14MC-2	14-well multi-channel compatible comb for use with 15 cm gel box, 2.0 mm thickness
14-223-934	HGB15-16-1	16-well comb for use with 15 cm gel box, 1.0 mm thickness
14-223-935	HGB15-16MC-1	16-well multi-channel compatible comb for use with 15 cm gel box, 1.0 mm thickness
14-223-936	HGB15-16MC-15	16-well multi-channel compatible comb for use with 15 cm gel box, 1.5 mm thickness
14-223-937	HGB15-16MC-2	16-well multi-channel compatible comb for use with 15 cm gel box, 2.0 mm thickness
14-223-938	HGB15-18MC-1	18-well multi-channel compatible comb for use with 15 cm gel box, 1.0 mm thickness
14-223-939	HGB15-18MC-15	18-well multi-channel compatible comb for use with 15 cm gel box, 1.5 mm thickness
14-223-940	HGB15-20-075	20-well comb for use with 15 cm gel box, 0.75 mm thickness
14-223-941	HGB15-20-1	20-well comb for use with 15 cm gel box, 1.0 mm thickness
14-223-942	HGB15-20-15	20-well comb for use with 15 cm gel box, 1.5 mm thickness
14-223-943	HGB15-20-2	20-well comb for use with 15 cm gel box, 2.0 mm thickness
14-223-944	HGB15-28MC-075	28-well multi-channel compatible comb for use with 15 cm gel box, 0.75 mm thickness
14-223-945	HGB15-28MC-1	28-well multi-channel compatible comb for use with 15 cm gel box, 1.0 mm thickness
14-223-946	HGB15-28MC-15	28-well multi-channel compatible comb for use with 15 cm gel box, 1.5 mm thickness
14-223-947	HGB15-30MC-1	30-well multi-channel compatible comb for use with 15 cm gel box, 1.0 mm thickness
14-223-948	HGB15-30MC-15	30-well multi-channel compatible comb for use with 15 cm gel box, 1.5 mm thickness
14-223-949	HGB15-35-15	35-well comb for use with 15 cm gel box, 1.5 mm thickness

**Axygen Horizontal Gel Box, 20 cm (1/case)**

Fisher Scientific Cat. No.	Corning Cat. No.	Description
14-223-903	HGB-20	Axygen horizontal gel box, 20 cm
14-223-952	HGB20-16-075	16-well comb for use with 20 cm gel box, 0.75 mm thickness
14-223-953	HGB20-20MC-075	20-well comb for use with 20 cm gel box, 0.75 mm thickness
14-223-954	HGB20-20MC-1	20-well multi-channel compatible comb for use with 20 cm gel box, 1.0 mm thickness
14-223-955	HGB20-20MC-15	20-well multi-channel compatible comb for use with 20 cm gel box, 1.5 mm thickness
14-223-956	HGB20-25-1	25-well comb for use with 20 cm gel box, 1.0 mm thickness
14-223-957	HGB20-30-1	30-well comb for use with 20 cm gel box, 1.0 mm thickness
14-223-958	HGB20-40MC-1	40-well multi-channel compatible comb for use with 20 cm gel box, 1.0 mm thickness
14-223-959	HGB20-40MC-15	40-well multi-channel compatible comb for use with 20 cm gel box, 1.5 mm thickness
14-223-960	HGB20-40MC-2	40-well multi-channel compatible comb for use with 20 cm gel box, 2.0 mm thickness
14-223-961	HGB20-50-2	50-well comb for use with 20 cm gel box, 2.0 mm thickness

**Gel Trays (1/case)**

14-223-963	HGB7-7-GT	Gel tray 7 x 7 cm for use with 7 cm gel box, UV transparent
14-223-962	HGB7-10-GT	Gel tray 7 x 10 cm for use with 7 cm gel box, UV transparent
14-223-964	HGB10-10-GT	Gel tray 10 x 10 cm for use with 10 cm gel box, UV transparent
14-223-965	HGB15-10-GT	Gel tray 15 x 10 cm for use with 15 cm gel box, UV transparent
14-223-966	HGB15-15-GT	Gel tray 15 x 15 cm for use with 15 cm gel box, UV transparent
14-223-967	HGB20-20-GT	Gel tray 20 x 20 cm for use with 20 cm gel box, UV transparent

**Replacement Electrodes (1/case)**

14-223-968	HGB7-NE	Replacement negative electrode, 7 cm
14-223-969	HGB7-PE	Replacement positive electrode, 7 cm
14-223-970	HGB10-NE	Replacement negative electrode, 10 cm
14-223-971	HGB10-PE	Replacement positive electrode, 10 cm
14-223-972	HGB15-NE	Replacement negative electrode, 15 cm
14-223-973	HGB15-PE	Replacement positive electrode, 15 cm
14-223-974	HGB20-NE	Replacement negative electrode, 20 cm
14-223-975	HGB20-PE	Replacement positive electrode, 20 cm

**Rubber Casting Dams (set of 2/case)**

14-223-976	HGB7-CD	Casting dams for use with 7 cm gel box
14-223-977	HGB10-CD	Casting dams for use with 10 cm gel box
14-223-978	HGB15-CD	Casting dams for use with 15 cm gel box
14-223-979	HGB20-CD	Casting dams for use with 20 cm gel box

**Accessories**

14-223-980	HGB7-AD	Power supply adapters, 4 mm to 4 mm, 2/pk
14-223-981	HGB7-AD2	Power supply adapters, 4 mm to 2 mm, 2/pk
14-223-982	HGB-EL	Electrical leads (1 pair)



# Axygen® MaxyGene II Thermal Cycler



The Axxygen MaxyGene II Thermal Cycler brings increased speed and advanced features, providing the premium performance you have come to expect from Axxygen brand products.

## Features

- ▶ Unique flexible programming
- ▶ Rapid run times
- ▶ Improved workflow over traditional gradient cyclers
- ▶ Ramping rates up to 5°C/sec.
- ▶ Simple user interface
- ▶ Adjustable heated lid accommodates strips, tubes, and microplates
- ▶ Pre-programmed standard protocols
- ▶ 3-year warranty

## Simplified Workflow for Improved Throughput

The Axxygen MaxyGene II Thermal Cycler is extremely simple to program, compact in design, and built to perform (Figure 1). It makes method optimization affordable and provides consistent, reliable results. Precision Thermal Control provides rapid heating and cooling of the precision-machined sample block by six independently temperature-controlled Peltier modules. A sophisticated algorithm program calculates sample temperature and triggers heating and cooling accordingly, minimizing over- and under-shooting.

The MaxyGene II Thermal Cycler may be programmed to operate between one and six different annealing temperatures across the block (Figure 2). This thermal cycler provides improved throughput by reducing time and simplifies workflow by reducing steps.

Figure 1. MaxyGene Thermal Cycler Screen

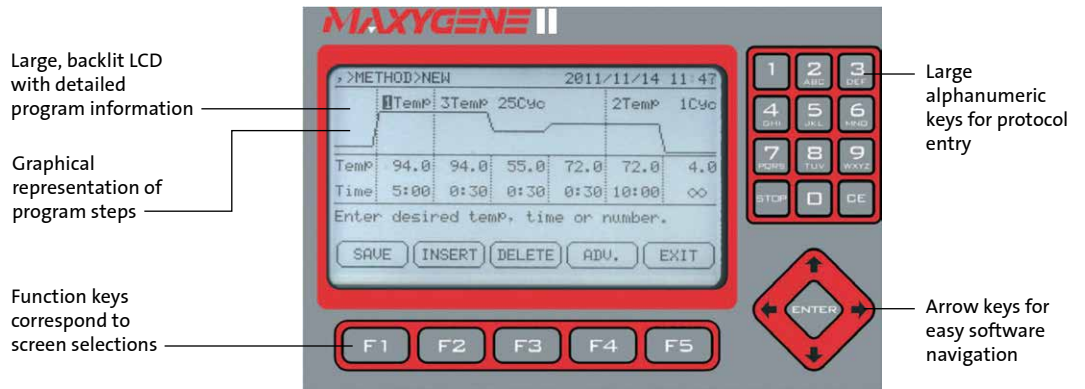
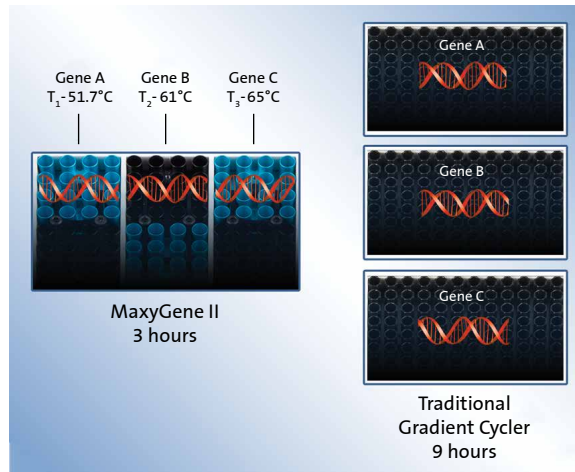

Figure 2. Primers designed to anneal to various genes (e.g., Gene A, B, and C) typically have different annealing temperatures ( $T_1$ ,  $T_2$ , and  $T_3$ ). The Axxygen MaxyGene II can perform up to six different reactions, significantly reducing steps and time.



A variety of applications can be performed with the Axygen® MaxyGene II, from single temperature soaks to sophisticated multi-step programs. All of these are easily set up. The time or temperature of a cycling step can be automatically increased or decreased during successive cycles. This is useful for “touchdown” applications and for extending annealing times as enzyme is depleted. Programs may also be paused while running. During operation, actual times and temperatures are displayed. Estimated run times are automatically calculated, and a log of the last run can be displayed or downloaded to a printer or PC.

### Specifications

Sample Capacity	1 x 96-well microplate, 128 x 0.2 mL strip tubes, 96 x 0.2 mL tubes
Programmable Temp. Range	4°C to 99.9°C
Temperature Control	Calculated or block
Temp. Accuracy/Uniformity	±0.5°C/±0.5°C
Max. Heating Range among the 6 Peltier Blocks	30°C to 99°C
Max. Temp Difference	24°C
Ramp Rates	5°C/sec. heating, 3.5°C/sec. cooling
Optimization Technology	Six 4 x 4 Peltier blocks with independently programmable temperatures
Programmable Lid Temperature	60°C to 65°C, 100°C to 115°C
Program Memory	200 complete programs
Temp. Increments/Decrements	Yes
Time Increments/Decrements	Yes
User Program Folders	Yes
Password Protected Programs	Yes
Communication	USB and RS232 ports
Dimensions (W x D x H)	24 x 43 x 25 cm
Weight	9 kg
Electrical	120V or 240V, 50/60 Hz

### Ordering Information

#### Axygen MaxyGene II Thermal Cycler

Fisher Scientific Cat. No.	Corning Cat. No.	Description	Qty/Pk	Qty/Cs
14-223-412	THERM-1001	MaxyGene II Thermal Cycler with 96-well block, 120V*	–	1

\*Other block formats are available. Contact Corning for details.

#### Compatible Axygen PCR Products

14-222-250	PCR-0208-C	0.2 mL clear thin wall PCR 8-strip tubes	125	1,250
14-222-251	PCR-0208-CP-C	0.2 mL clear thin wall PCR 8-strip tubes and clear 8-strip caps	125	1,250
14-222-252	PCR-0208-FCP-C	0.2 mL clear thin wall PCR 8-strip tubes and clear flat 8-strip caps with writing surface	125	1,250
14-222-262	PCR-02-C	0.2 mL clear flat cap thin wall PCR tubes	1,000	10,000
14-222-273	PCR-02D-C	0.2 mL clear domed cap thin wall PCR tubes	1,000	10,000
14-222-281	PCR-02-FCP-C	0.2 mL clear flat PCR 8-strip caps with writing surface	125	1,250
14-222-302	PCR-2CP-RT-C	0.2 mL clear 8-strip caps for real-time PCR	125	1,250
14-222-322	PCR-96-FLT-C	96-well clear flat top non skirt PCR microplate	25	100
14-222-326	PCR-96-FS-C	96-well clear full skirt PCR microplate	10	50
14-224-003	PCR-96-FS-C-PBC	96-well clear full skirt PCR microplate with bar code	10	50
14-222-332	PCR-96-FS-W	96-well white full skirt PCR microplate	10	50
14-222-340	PCR-96M2-HS-C	96 well clear half skirt PCR microplate with a single notch	10	50
14-224-002	PCR-96M2-HS-C-PBC	96-well clear half skirt PCR microplate with a single notch with barcode	10	50
14-222-347	PCR-TS	PCR tight seal thermal sealing film for all thermal cyclers	100	500
14-222-873	UC-500	Optically clear pressure sensitive sealing film	100	500



# Axygen® PlateMax Semi-automatic Plate Sealer



Easy-to-set time and temperature settings

## Compact Footprint

The Axygen PlateMax semi-automatic plate sealer is ideal for the low to medium throughput laboratory that requires uniform and consistent sealing of microplates. Sealing parameters are set and displayed via the user-friendly control panel and the sealing operation is automated to ensure consistent results.

## Intuitive Layout

The PlateMax sealer control system features an intuitive layout with settings for all types of plates and sealing materials. The Mode button selects sealing time or temperature, and the control knob adjusts the setting.

Temperature can be precisely set in increments of 1°C and time in increments of 0.1 seconds. The PlateMax has a power saving option that turns the heater off if not in use. For those labs that choose to turn this function off, you can have the PlateMax ready to run all day.

- ▶ Accepts a wide range of microplates and heat seals
- ▶ User-friendly control system
- ▶ Large digital display shows all operating parameters
- ▶ Adjustable sealing temperature
- ▶ Precise temperature, timing, and pressure for consistent sealing

## Simple 3-step Operation

1. Set time and temperature.
2. Place a microplate in the open drawer.
3. Place a heat seal on top of the plate and press the "SEAL" button.

## Versatile and Convenient

The PlateMax sealer accepts a wide variety of plate types and heights. An aluminum adapter is used for PCR and standard assay plates. The motorized heated platen automatically adjusts for different plate heights and provides uniform pressure to ensure a quality seal. The platen incorporates a special non-stick coating. The side access door allows for easy cleaning.

## Safe

The internal heating elements are situated inside the instrument casing and an internal safety door prevents access to the heated area. In addition, the motorized drawer features safety switches. If a hand or object obstructs the closing drawer, the drawer motor will reverse. This feature protects both the user and the instrument.

## Specifications

Dimensions (W x D x H)	6.75 x 12.75 x 14.25 in. (171 x 324 x 362 mm)
Weight	27 lbs. (12 kg)
Sealing Temperature	OFF, 100°C to 190°C (increments of 1.0°C)
Temperature Accuracy	±1.0°C
Temperature Uniformity	±1.0°C
Sealing Time	0.5 to 10 sec. (increments of 0.1 sec)
Compatible Plate Materials	PP (Polypropylene), PS (Polystyrene), PE (Polyethylene)
Compatible Plate Types	Standard assay plates, deep-well storage plates, PCR plates: skirted, semi-skirted, non-skirted
Maximum Plate Height	45 mm
Compatible Sealing Film Types	Foil-polypropylene laminate Clear polyester-polypropylene laminate Clear polymer Thin clear polymer Foil-laminate Foil

## Ordering Information

### Axygen® PlateMax Semi-automatic Plate Sealers

Fisher Scientific Cat. No.	Corning Cat No.	Description	Qty/ Unit	Units/ Cs
14-223-203	HS-1120	PlateMax semi-automatic plate sealer, 120V, includes adapters for standard and deep-well microplates	–	1
14-223-204	HS-1230	PlateMax semi-automatic plate sealer, 230V, includes adapters for standard and deep-well microplates	–	1

### Related Products

14-223-068	HS-100-QPCR	PlateMax UltraClear permanent heat sealing film for qPCR	100	5
14-223-206	HS-150-QPCR	PlateMax UltraClear peelable heat sealing film for qPCR	100	5
14-223-207	HS-200	PlateMax peelable heat sealing film for low temperature compound storage and PCR	100	5
14-223-208	HS-300	PlateMax pierceable heat sealing film for low temperature compound storage and PCR	100	5
14-223-209	HS-400	PlateMax peelable heat sealing film for compound storage	100	5
14-222-191	MF-300	PlateMax peelable heat sealing film with paper backing for general storage and PCR applications	100	1

# Axygen® Axyspin Refrigerated Microcentrifuge



The Axyspin refrigerated microcentrifuge is a high performance refrigerated microcentrifuge designed to quickly process samples for applications such as nucleic acid and protein preparation, purifications, extractions, and pelleting.

- ▶ Powerful refrigeration system cools to 4°C in 8 minutes
- ▶ 24 x 1.5/2.0 mL aluminum rotor included
- ▶ Exceptionally quiet and compact

## Axygen Axyspin Refrigerated Microcentrifuge

The Axyspin refrigerated microcentrifuge combines a powerful yet silent, brushless drive with an efficient cooling system, all in a compact footprint. Brushless drive technology has been fine-tuned in the Axyspin refrigerated microcentrifuge to deliver fast acceleration and deceleration of the solid aluminum rotor. The uniquely designed 24-place rotor allows easy access to the tops of sample tubes. Starting from room temperature, the chamber of the Axyspin refrigerated microcentrifuge cools to 4°C in just 8 minutes. The control panel features a backlit LCD display, which allows users to easily view running parameters while the large control knob facilitates digital setting of rotor speed, run time, and temperature. These high performance features allow for faster sample processing and less down time.

The rotor of the Axyspin refrigerated microcentrifuge can accommodate 1.5 and 2.0 mL Axyspin microcentrifuge tubes, including the most popular catalog numbers (MCT-150-C and MCT-200-C).

## Specifications

Speed Range	500 to 13,500 rpm
Maximum RCF	17,135 x g
Maximum Capacity	24 x 1.5/2.0 mL
Timer	0.5 to 99 minutes, or continuous 0.5 to 99 minutes, or continuous "Quick" button for momentary operation
Temperature Range	-10° to 40°C
Dimensions (W x D x H)	10.9 x 17.75 x 9.75 in. (27.7 x 45 x 24.75 cm)
Weight	44 lbs. (20 kg)
Electrical	100V-230V, 50/60 Hz

## Ordering Information

### Axygen Axyspin Refrigerated Microcentrifuge

Fisher Scientific Cat. No.	Corning Cat. No.	Voltage	Plug Type	Qty/Cs
14-223-069	601-05-031	120V	US	1

### Axygen Axyspin MaxyClear SnapLock Microcentrifuge Tubes

Fisher Scientific Cat. No.	Corning Cat. No.	Description	Qty/Pk	Qty/Cs
14-222-155	MCT-150-C	1.5 mL	500	5,000
14-222-180	MCT-200-C	2.0 mL	500	5,000

# Axygen® Axyspin Mini Plate Spinner Centrifuge



The Axygen Axyspin Plate Spinner is the first centrifuge designed specifically for quick and easy centrifugation of samples in PCR plates.

- ▶ Capacity for two standard plates
- ▶ Top loading design
- ▶ Exceptionally small footprint
- ▶ Starts and stops in seconds

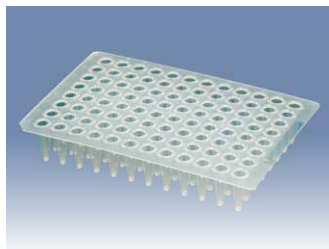

## Specifications

Speed	2,500 rpm
Maximum RCF	500 x g
Maximum Capacity	2 standard PCR microplates
Ambient Operating Range	4°C to 35°C
Dimensions	6 x 6 x 7 in. (16 x 16 x 18 cm)
Weight	3.3 lbs. (1.5 kg)

## Ordering Information

### Axygen Axyspin Mini Plate Spinner Centrifuge

Fisher Scientific Cat. No.	Corning Cat. No.	Voltage	Plug Type	Qty/Cs
14-223-068	Platespinner-120	120V/60Hz	US	1/each

For related PCR products, see page 9.

# Axygen® Axypet® Pro Single- and Multi-channel Pipettors



Axygen Axypet Pro Pipettors have been engineered to provide the highest levels of comfort, accuracy, and precision. The lightweight construction, contoured handle, and 4-digit counter were designed to ensure comfortable pipetting. All pipettors feature smooth plunger movement and extremely low pipetting forces to reduce wrist strain and fatigue (RSI). Colored pushbuttons enable easy size identification and reduce the risk of cross-contamination.

- ▶ Ergonomic handle design is a perfect fit for both the right and left hand
- ▶ Convenient one-hand volume setting with auto-lock system prevents accidental volume change during work
- ▶ 4-digit counter provides greater precision and is perfectly positioned for visibility at all times
- ▶ Single-channel pipettors are compatible with very narrow tubes
- ▶ Fully autoclavable and UV-resistant for sample protection against contaminations
- ▶ The multi-channel shafts retract individually for perfect tip loading and easier tip ejection
- ▶ Unique ejector lever system enables effortless tip ejection
- ▶ Easy in-lab calibration helps you quickly adjust your pipettor to various liquid types
- ▶ Individually tested and supplied with a certificate of quality
- ▶ 3-year warranty

## Axygen Axypet Pro Starter Kit

Axygen Axypet Pro Starter Kit contains four variable volume pipettors in the most popular and universal volumes (0.5-10 µL, 2-20 µL, 20-200 µL, and 100-1000 µL), pipettor stand for four pipettors, and 3 racks with tips.

## Ordering Information

### Axygen Axypet Pro Pipettors

#### Single-channel

Fisher Scientific Cat. No.	Corning Cat. No.	Volume Range (µL)	Accuracy (%)	Precision (%)	Non-filtered Tip (µL)	Qty/Cs
07-202-432	AP-2-P	0.1 - 2	±40.0 to ±1.5	≤12.0 to ≤0.7	10	1
07-202-433	AP-10-P	0.5 - 10	±4.0 to ±1.0	≤2.8 to ≤0.4	10	1
07-202-434	AP-20-P	2 - 20	±3.5 to ±0.8	≤1.5 to ≤0.3	200	1
07-202-435	AP-50-P	5 - 50	±3.5 to ±0.8	≤1.3 to ≤0.3	200	1
07-202-436	AP-100-P	10 - 100	±3.0 to ±0.8	≤1.0 to ≤0.2	200	1
07-202-437	AP-200-P	20 - 200	±2.0 to ±0.6	≤0.7 to ≤0.2	200	1
07-202-438	AP-1000-P	100 - 1000	±2.5 to ±0.6	≤0.6 to ≤0.2	1000	1

#### 8-channel

07-202-439	AP-8-10-P	0.5 - 10	±10.0 to ±2.0	≤8.0 to ≤1.2	10	1
07-202-440	AP-8-50-P	5 - 50	±4.0 to ±1.6	≤2.5 to ≤0.6	200	1
07-202-441	AP-8-200-P	20 - 200	±3.0 to ±1.0	≤1.5 to ≤0.6	200/300	1
07-202-442	AP-8-300-P	30 - 300	±3.0 to ±1.0	≤1.5 to ≤0.6	300	1

#### 12-channel

07-202-443	AP-12-10-P	0.5 - 10	±10.0 to ±2.0	≤8.0 to ≤1.2	10	1
07-202-444	AP-12-50-P	5 - 50	±4.0 to ±1.6	≤2.5 to ≤0.6	200	1
07-202-445	AP-12-200-P	20 - 200	±3.0 to ±1.0	≤1.5 to ≤0.6	200/300	1
07-202-446	AP-12-300-P	30 - 300	±3.0 to ±1.0	≤1.5 to ≤0.6	300	1

### Axygen Axypet Pro Starter Kit

Fisher Scientific Cat. No.	Corning Cat. No.	Description	Qty/Cs
07-202-447	AP-STR-KIT-P	Axygen Axypet Pro Starter Kit Includes: 4 single-channel pipettors: 0.5 to 10 µL (Cat. No. AP-10-P), 2 to 20 µL (Cat. No. AP-20-P), 20 to 200 µL (Cat. No. AP-200-P), 100 to 1000 µL (Cat. No. AP-1000-P); universal linear stand for four single-channel pipettors (Cat. No. AP-USD4-P); Axxygen MultiRack pipet tips: 10 µL (Cat. No. MR-10XT-R), 200 µL (Cat. No. MR-200-R), 1000 µL (Cat. No. MR-1000XT-R)	1



Axygen Axypet Pro Starter Kit

# Axygen® Axypet® Single- and Multi-channel Pipettors



Axygen Axypet single- and 8-channel pipettors



Axygen Axypet 12-channel pipettor

Axygen Axypet pipettors combine high levels of accuracy and precision with design innovations to make pipetting more comfortable during prolonged periods of time.

- ▶ Thumb-friendly soft spring pipetting system reduces fatigue
- ▶ Unique side EZject button option reduces thumb movement\*
- ▶ Large ergonomic push button is easy on the thumb during contact
- ▶ Locking feature prevents accidental volume changes during pipetting procedures
- ▶ Micrometer is continuously adjustable for selection of whole or fractional volumes

Additional multi-channel pipettor features:

- ▶ Curved ejector bar allows tips to be ejected in steps, reducing the amount of force required for ejection
- ▶ Tip manifold rotates 360°
- ▶ Shafts withdraw when pressed against a row of tips
- ▶ Each shaft moves independently, minimizing jamming of tips

## Ordering Information

### Axygen Axypet Single- and Multi-channel Pipettors

#### Single-channel Pipettors

Fisher Scientific Cat. No.	Corning Cat. No.	Volume Range (µL)	Channels	Accuracy (Min/Max)	Precision (Min/Max)	Non-filtered (µL)	Qty/Cs
14-223-568	AP-2	0.1 - 2	1	±40.0/±1.5%	≤12.0/≤0.7%	10	1
14-223-560	AP-10	0.5 - 10	1	±4.0/±0.5%	≤2.8/≤0.4%	10	1
14-223-569	AP-20	2 - 20	1	±3.0/±0.8%	≤1.5/≤0.3%	200	1
14-223-572	AP-50	5 - 50	1	±2.5/±0.8%	≤2.0/≤0.4%	200	1
14-223-561	AP-100	10 - 100	1	±1.6/±0.8%	≤0.8/≤0.2%	200	1
14-223-570	AP-200	20 - 200	1	±1.2/±0.6%	≤0.6/≤0.2%	200	1
14-223-571	AP-250	50 - 250	1	±1.0/±0.6%	≤0.4/≤0.3%	300	1
14-223-562	AP-1000	100 - 1,000	1	±1.6/±0.6%	≤0.4/≤0.15%	1,000	1
14-223-573	AP-5000	1,000 - 5,000	1	±0.6/±0.5%	≤0.25/≤0.15%	5,000	1
14-223-563	AP-10ML	1,000 - 10,000	1	±2.5/±0.5%	≤0.6/≤0.2%	10,000	1

#### Multi-channel Pipettors

14-223-574	AP-8-10	1 - 10	8	±8.0/±2.0%	≤6.0/≤1.2%	10	1
14-223-577	AP-8-50	5 - 50	8	±4.0/±1.6%	≤2.5/≤0.6%	200	1
14-223-575	AP-8-200	20 - 200	8	±3.0/±1.0%	≤1.5/≤0.6%	200/300	1
14-223-576	AP-8-300	50 - 300	8	±1.6/±1.0%	≤1.5/≤0.6%	300	1
14-223-564	AP-12-10	1 - 10	12	±8.0/±2.0%	≤6.0/≤1.2%	10	1
14-223-567	AP-12-50	5 - 50	12	±4.0/±1.6%	≤2.5/≤1.6%	200	1
14-223-565	AP-12-200	20 - 200	12	±3.0/±1.0%	≤1.5/≤0.6%	200/300	1
14-223-566	AP-12-300	50 - 300	12	±1.6/±1.0%	≤1.5/≤0.6%	300	1

\*Left handed EZject button available by special order.





Axygen Axypet starter kit

### Axygen Axypet Starter Kits

Fisher Scientific Cat. No.	Corning Cat. No.	Description	Qty/Cs
14-223-580	AP-STR-KIT-1	Axygen Axypet Starter Kit-1 Includes: AP-20, AP-200, and AP-1000 pipettors; 1 rack each of 200 $\mu$ L and 1000 $\mu$ L Axygen tips; calibration tool; ejector spacers set; identification labels; lubricant; color identification rings; right-hand ejector button	1
14-223-581	AP-STR-KIT-2	Axygen Axypet Starter Kit-2 Includes: AP-10, AP-100, and AP-1000 pipettors; 1 rack each of 10 $\mu$ L, 200 $\mu$ L, and 1200 $\mu$ L Axygen tips; calibration tool; ejector spacers set; identification labels; lubricant; color identification rings; right-hand ejector button	1

### Axygen® Axypet® Pipettor Accessories

Fisher Scientific Cat. No.	Corning Cat. No.	Description	Qty/Cs
14-223-582	AP-USD	Pipettor stand for one single-channel, 8-channel, or 12-channel pipettor	1
14-223-583	AP-USD4	Universal linear stand for four pipettors, transparent (four single-channel, maximum of two 8-channel or 12-channel pipettors)	1
07-202-456	AP-USD4-P	Universal linear stand for four pipettors, red (four single-channel, maximum of two 8-channel or 12-channel pipettors)	1
07-202-457	AP-USD6	Universal linear stand for six pipettors, transparent (six single-channel, maximum of three 8-channel or 12-channel pipettors)	1
14-223-578	AP-CSD	Carousel stand for six single-channel pipettors (not compatible with Axygen Axypet Pro pipettor)	1



Universal linear 4-place stand



Carousel stand for six single-channel pipettors



Universal linear stand for one pipettor



Universal linear stand for four pipettors



Universal linear stand for six pipettors

# Axygen® Axypet® 16-channel Pipettor



Ergonomic tip ejection lever

The Axypet 16-channel pipettor features a comfortable, lightweight design to help reduce hand fatigue, as well as an ergonomically designed ejector lever. Each channel of the pipettor has an individual piston assembly to ensure accuracy and precision when working at micro-volume levels. The tip holder allows for effortless and leak-free tip mounting, while the micrometer is continuously adjustable for selection of whole or fractional volumes.

Axypet 16-channel pipettor features:

- ▶ Compatible with 384-well microplates
- ▶ Ambidextrous design
- ▶ One-hand volume setting
- ▶ Color-coded volume controls for quick and easy selection
- ▶ Fully autoclavable pipettor body (except volume control)
- ▶ Tip manifold rotates 360°

## Ordering Information

### Axygen Axypet 16-channel Pipettor

Fisher Scientific Cat. No.	Corning Cat. No.	Volume Range (µL)	Channels	Accuracy (Min/Max)	Precision (Min/Max)	Qty/Cs
14-222-928	AP-16-2	0.2 - 2	16	±24.0/±4.0%	≤12.0/≤2.0%	1
14-222-927	AP-16	1.0* - 10	16	±5.0/±2.0%	≤3.6/≤1.0%	1
14-222-929	AP-16-50	5 - 50	16	±3.2/±1.40%	≤1.6/≤0.6%	1

\*Minimum volume is 0.5 µL.

### Compatible Axypet Pipet Tips

These polypropylene tips are RNase-/DNase-free and nonpyrogenic. Flexible walls and internal sealing rings ensure a secure fit with less force required to load and eject. Exclusive Axypet Maximum Recovery® technology provides ultra-low retention and high yield.

Fisher Scientific Cat. No.	Corning Cat. No.	Product Description	Volume Range (µL)	Tips/Rack	Racks/Pk	Racks/Cs	Qty/Cs
14-222-710	T-1536-R	30 µL pipet tips, clear	0.5 - 30	384	10	5	19,200
14-222-711	T-1536-R-S	30 µL pipet tips, clear, sterile	0.5 - 30	384	10	5	19,200
14-223-372	T-1536-L-R	30 µL Maximum Recovery pipet tips, clear	0.5 - 30	384	10	5	19,200
14-223-373	T-1536-L-R-S	30 µL Maximum Recovery pipet tips, clear, sterile	0.5 - 30	384	10	5	19,200

# Axygen® MotoPet® Pipet Controller



Pressure sensitive trigger buttons control rate of aspiration or dispensing.

Axygen MotoPet is a precise, motor powered, rechargeable pipet controller for volumes ranging from 0.5 mL to 100 mL. The unit has an ergonomic design and a highly efficient motor for fast aspiration and dispense of samples as large as 100 mL and full control and precision while dispensing volumes as small as 0.5 mL. It is compatible with both glass and plastic pipets.

## Features

- ▶ Molded, lightweight handle for effortless pipetting even during extended use.
- ▶ Easily accessible switches allow you to choose the optimal operation mode depending on the volume and viscosity of the sample.
- ▶ PTFE filter prevents liquid from entering the unit.

## Specifications

Volume Range	0.5 mL to 100 mL
Weight	230 g
Speed Settings	2 (high and low)
Dispensing Modes	2 (gravity and blow-out)
Filter	PTFE
Power Source	NiMH battery, up to 8 hours of continuous work
Sterilization	Nosepiece, pipet holder, and filter are autoclavable.



Battery charging station included.



PTFE filter protects samples from cross-contamination. The filter is autoclavable.



Digital display provides visual indication of battery condition, motor speed, and operating function.



Aspiration speed can be set to HIGH or LOW to adjust for the volume of the pipet and viscosity of the liquid.

## Ordering Information

### Axygen MotoPet Pipet Controller

Fisher Scientific Cat. No.	Corning Cat. No.	Description	Qty/Cs
14-223-584	MOTOPET-1	Axygen MotoPet cordless pipet controller, includes charger, wall hanger, and PTFE filter (0.2 µm)	1

For more specific information on claims, visit the Certificates page at [www.corning.com/lifesciences](http://www.corning.com/lifesciences).

**Warranty/Disclaimer:** Unless otherwise specified, all products are for research use only. Not intended for use in diagnostic or therapeutic procedures. Corning Life Sciences makes no claims regarding the performance of these products for clinical or diagnostic applications.

For a listing of trademarks, visit [www.corning.com/clstrademarks](http://www.corning.com/clstrademarks). All other trademarks are the property of their respective owners.

Contact us today:

**In the United States**

Order online: [fishersci.com](http://fishersci.com)

Fax an order: 1-800-926-1166

Call customer service: 1-800-766-7000

**In Canada**

Order online: [fishersci.ca](http://fishersci.ca)

Fax an order: 1-800-463-2996

Call customer service: 1-800-234-7437

