



Thermo Scientific
Good Laboratory
Pipetting (GLP) Practices

good laboratory
pipetting practices

Thermo
SCIENTIFIC

Leading provider of innovative pipetting systems

You can improve accuracy and precision when you combine the right **pipetting tools, technique, ergonomics, and service** with the most critical factor: the skill and expertise of the operator. Let us show you how with over 50 years of liquid handling experience.

▶ This comprehensive Good Laboratory Pipetting (GLP) guide will help you achieve better results by providing tips on advancing your skills so **you can handle anything**.



TOOLS



TECHNIQUES



ERGONOMICS



SERVICE

Table of contents:

- 1 Liquid handling tool selection** – Choose the best option, from pipette to tip
- 2 Proper pipetting techniques** – Improve your results with proper technique
- 3 Ergonomics** – Ensure your daily environment fits you comfortably
- 4 Maintenance and service** – Secure the quality of your results

History of Thermo Scientific™ Innovation

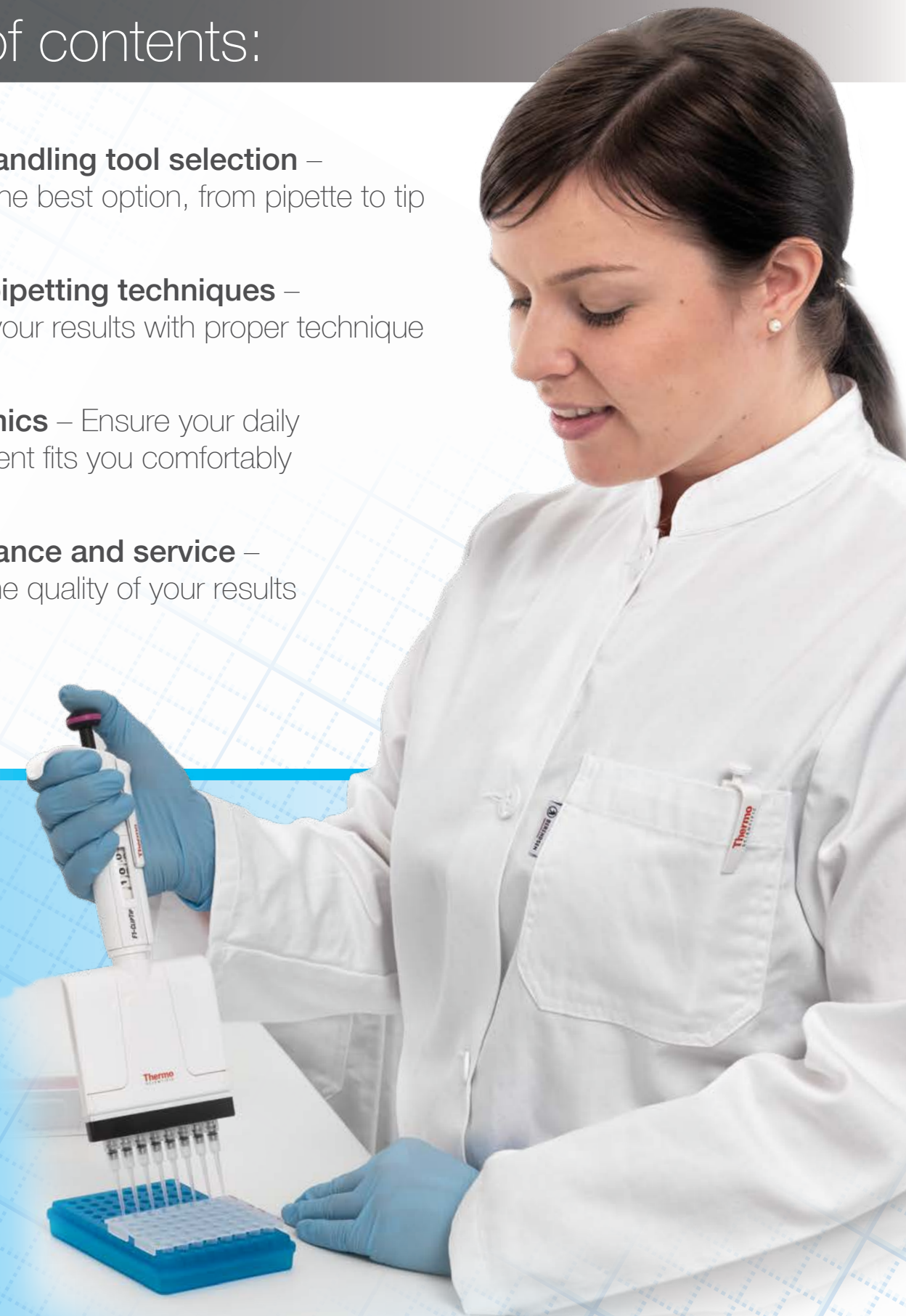
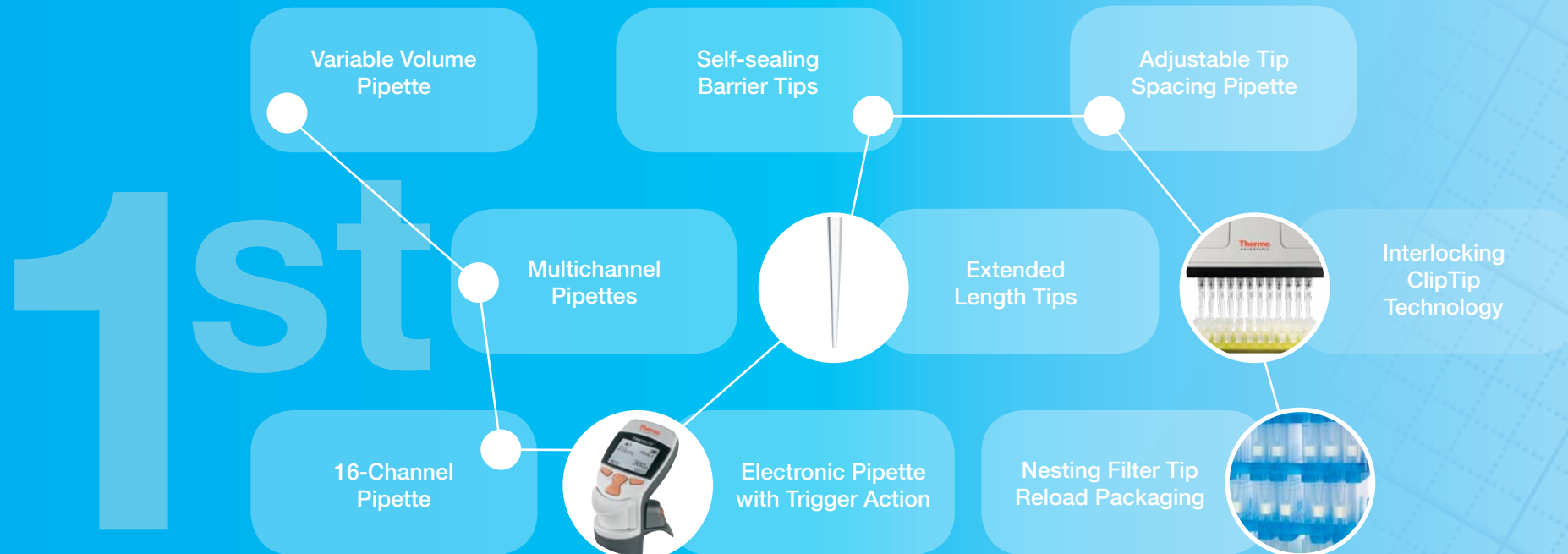

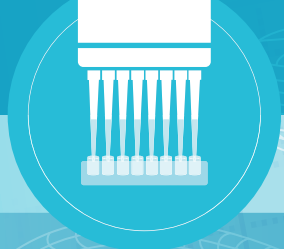

Liquid handling tool selection – Choose the best option, from pipette to tip

There are two types of pipettes:



Thermo Scientific™ F1-ClipTip™ 12-Channel Pipette

Air displacement pipettes - meant for general use with aqueous solutions

Positive displacement pipettes - used for highly viscous and volatile liquids



Thermo Scientific™ FinnpiPETTE™ Stepper Pipette

Both pipette types have a piston that moves in a cylinder or capillary. In air displacement pipettes, a certain volume of air remains between the piston and the liquid. In positive displacement pipetting, the piston is in direct contact with the liquid.

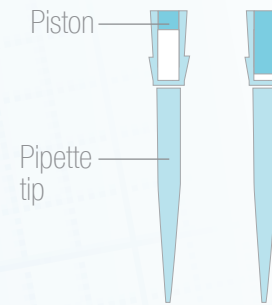

Air Displacement Pipettes:

Air displacement pipetting is highly accurate for standard pipetting applications. However, temperature and atmospheric pressure, as well as the specific gravity and viscosity of the solution, may affect the performance of air displacement pipettes.

How air displacement pipettes work

Aspirating the liquid (steps 1-3)

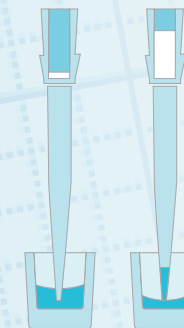

1. The piston moves to the appropriate position when the volume is set.
2. When the operating button is pressed to the first stop, the piston expels the same volume of air as indicated on the volume setting.
3. After immersing the tip into the liquid, the operating button is released. This creates a partial vacuum, and the specified volume of liquid is aspirated into the tip.

Dispensing the liquid (step 4)

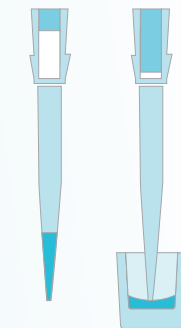

4. When the operating button is pressed to the first stop again, the air dispenses the liquid. To empty the tip completely, the operating button is pressed to the second stop (blow-out).

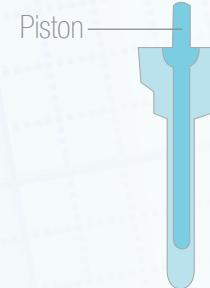

Positive Displacement Pipettes:

Positive displacement pipetting is based on direct contact of the piston with the liquid. The aspirated liquid amount depends on the dimensions of the cylinder or capillary and the movement distance of the piston. In positive displacement pipettes the tips contain both the cylinder/capillary and the piston.

How positive displacement pipettes work



1. The piston moves down inside the tip to make direct contact with the sample.

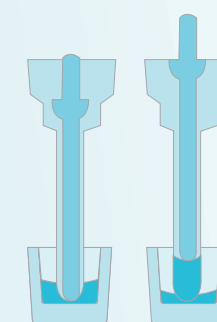

2. The piston moves up to draw the sample into the tip.

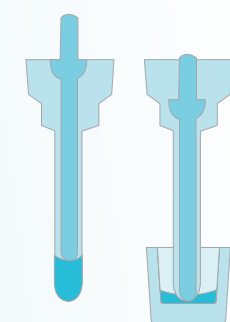

3. When dispensing, the piston descends and the selected volume is dispensed.

Pipette tip selection – Select the correct tip for ideal sample recovery

There is a pipetting system for virtually every application and requirement. The type of experiment you are performing and the physical properties of the liquid will determine the correct pipette tip to use.

Standard Tips

A standard tip is a multi-purpose tip for many laboratory applications with a variety of performance requirements that range from high accuracy to reagent dispensing with greater tolerance. Sterile standard tips are available for applications demanding the highest level of purity.

Sterile Filter Tips

A filter tip is beneficial when the assay is sensitive to cross-contamination, or if the sample can contaminate the lower part of the pipette. The filter prevents liquid from accidentally splashing the inside of the pipette, and reduces aerosols from penetrating the pipette tip cone during pipetting. Filter tips are recommended for low volume applications in genetic studies, forensics, PCR, and radioisotope sampling. They are available with either self-sealing barrier or standard filter tips – both of which are designed to prevent cross-contamination.

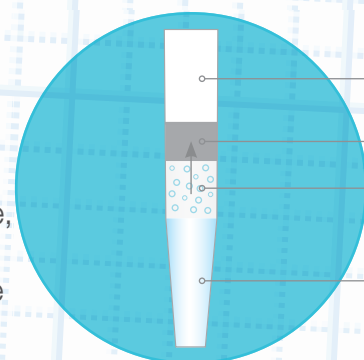

NO contamination
Self-sealing barrier
Aerosol contamination
Sample

**Thermo Scientific™
ART™ tips** -
▶ Watch how ART
barrier tips work

Extended Length Pipette Tips

Extended length tips allow you to access the bottom of test tubes, reagent bottles, flasks, and other vessels without touching the shaft of the pipette against the side of the tube. This adds a layer of security to protect samples, and virtually eliminates the chance of carryover contamination. The longer tip length allows you to reach the bottom of long or narrow vessels that standard tips cannot reach.

**Choosing the correct tip for your application
will ensure ideal accuracy and precision.**

Low Retention Pipette Tips

Utilizing polymer technology makes the inner surface of the pipette tip more hydrophobic, resulting in a significant reduction in sample loss due to adhesion. Benefits include improved sample delivery and conservation of expensive reagents.

Specialty Tips

Specialty tips are designed for unique pipetting applications to save time, reduce contamination, and increase accuracy, precision, and productivity.

Wide Orifice Tips

Wide orifice tips feature a distal end orifice that is nearly 70 percent larger than that of a standard pipette tip. These tips provide the added flexibility required for handling difficult-to-pipette samples. They are designed for researchers working with macromolecules like genomic DNA and are especially critical for transferring fragile cellular samples such as macrophages, hybridomas, and hepatocytes, as well as other viscous materials.

Did you know that we have the broadest selection of pipette tips?



Learn more about Thermo Scientific ClipTip, Finntip, ART, QSP* tips, and others at www.thermoscientific.com/pipettetips

*Available in certain countries



Gel Loading Tips

Loading acrylamide or agarose gels with standard pipette tips can be a time-consuming process. Use the round gel loading tips for agarose gels and specialized Ultra Round and Ultra Flat gel tips for your polyacrylamide gels to speed up the loading process.

Solvent Safe Carbon Filtered Tips

Solvent-safe carbon filtered pipette tips are the best solution for handling the pipetting rigors of Combinatorial Chemistry. These specialized tips keep strong acids, bases, and aggressive organic solvents from causing pipette failures and critical inaccuracies.

Individually Wrapped Tips

For extremely sensitive applications, single-wrapped tips are available. Individually-wrapped sterile tips are ideal for extremely sensitive applications requiring strict aseptic conditions.

Genomic (wide orifice)



ART 200G Wide Bore

Extended length



Finntip 1000 EXT

Gel loading



ART 20P Gel Loading

Solvent safe



ART 200 Solvent Safe

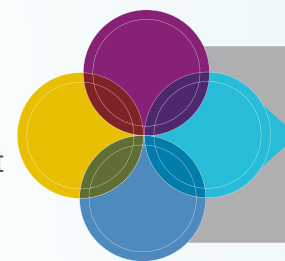

Improve Gel Loading
for PCR Analysis
Read the app note

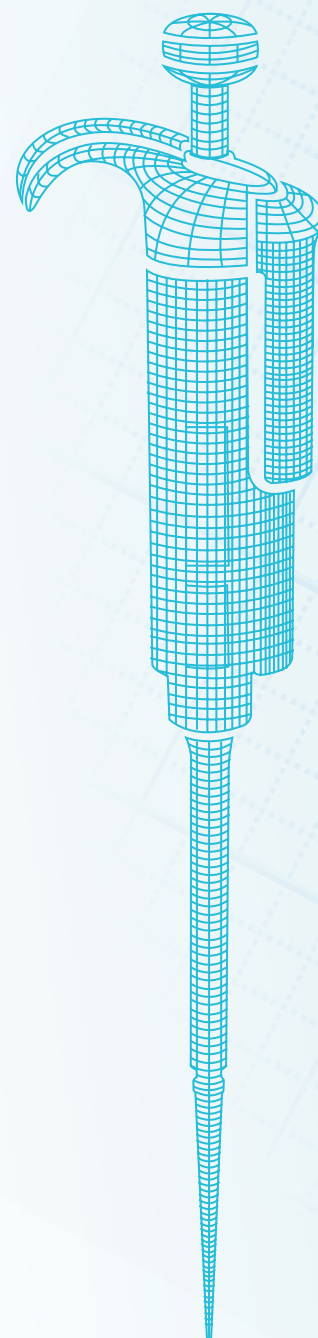

Finnpipette F1 200 μ l
single channel pipette

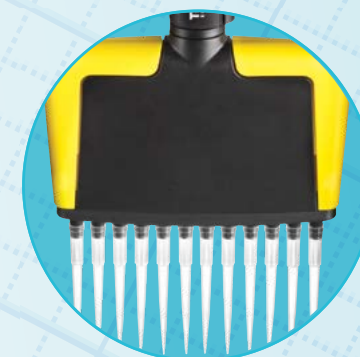

Finnpipette F2 100 μ l
12-channel pipette



E1-ClipTip Adjustable Tip
Spacing Equalizer 6-ch pipette



Finnpipette Stepper

Pipetting in Different Applications

Due to their versatility and wide volume range, **variable volume air displacement single-channel pipettes** are the most used laboratory instruments. The same pipette can be used for multiple applications.

Multichannel pipettes are most commonly used in microplate applications, such as ELISA, PCR, or cell culture. Manual multichannel pipettes offer instant usability for small scale multichannel work. Multichannel pipettes are available as 8- or 12-channel versions to work with 96-well microplates, and as a 16-channel version to work with 384-well microplates.

In applications where a lot of repetitive pipetting is performed, an electronic pipette provides a significant ergonomic benefit. **Electronic pipettes** are versatile laboratory workhorses that can be programmed to perform most laboratory tasks. The most commonly used function of electronic pipettes is the aliquoting of a reagent into multiple doses - multidispensing.

By using a **multichannel electronic pipette** and repeat dispensing modes in microplate filling, the time needed for filling the plate can be reduced from several minutes to less than a minute. Electronic pipettes that offer **adjustable tip spacing** increase efficiency in samples transfers to move several samples at once between different labware formats.

Serological pipets are used in cell and tissue culture applications, and in general laboratory liquid dosage when more than 1 ml volumes are pipetted. Serological pipets are made of glass or polystyrene. Plastic, disposable pipets are useful in applications where sterility is a requirement. Serological **Pipet Fillers** help to aspirate and dispense liquids accurately and with precision. The speed of both aspiration and dispensing can be adjusted separately to work with a variety of liquids.

Manual Stepper pipettes are ideal for simple repetitive tasks with a dispensing range up to 5 ml. A **bulk reagent dispenser** is a reliable and easy tool for dispensing reagents directly from the reagent bottle. A dispenser offers speed and accuracy with no extra work steps in everyday liquid dispensing.

The System Solution – Increase reliability, reproducibility, better results

Good Laboratory Pipetting practices significantly influence the results of your liquid handling. The performance of your pipette is key and is a result of several factors, which include ensuring desired specifications are met. Using the precisely manufactured pipette tips designed to work together as a system with your pipette greatly improves your results. A pipette's performance is directly related to the quality of the pipette tip—a **pipette is only as good as its tip**.

We know it's a challenge to ensure proper tip sealing in daily pipetting. The ideal solution is for the pipette and tip to form a system that increases confidence in reproducibility, reduces forces required to attach and detach the tip, and secures the best possible accuracy and precision.

Did you know Thermo Scientific pipette tips are designed, developed, and manufactured to perfectly fit Thermo Scientific pipettes?

We know it's a challenge to ensure a proper tip seal in daily pipetting. The ideal solution is for the pipette and tip to form a system to increase confidence in reproducibility, reduce forces required to attach and detach the tip, and secure the best possible accuracy and precision.

Pipetting Systems provide:

- A significant improvement in pipetting performance for consistent and reproducible liquid handling results.
- A reduction in attachment and ejection forces for ergonomic comfort.
- A decrease in visible pipette nose cone wear, which is common when using generic tips.
- An increase in the life of the pipette.
- Easy identification with color-coding of specific volume ranges for both pipettes and tips.

ClipTip Pipetting System

[Download the brochure.](#)

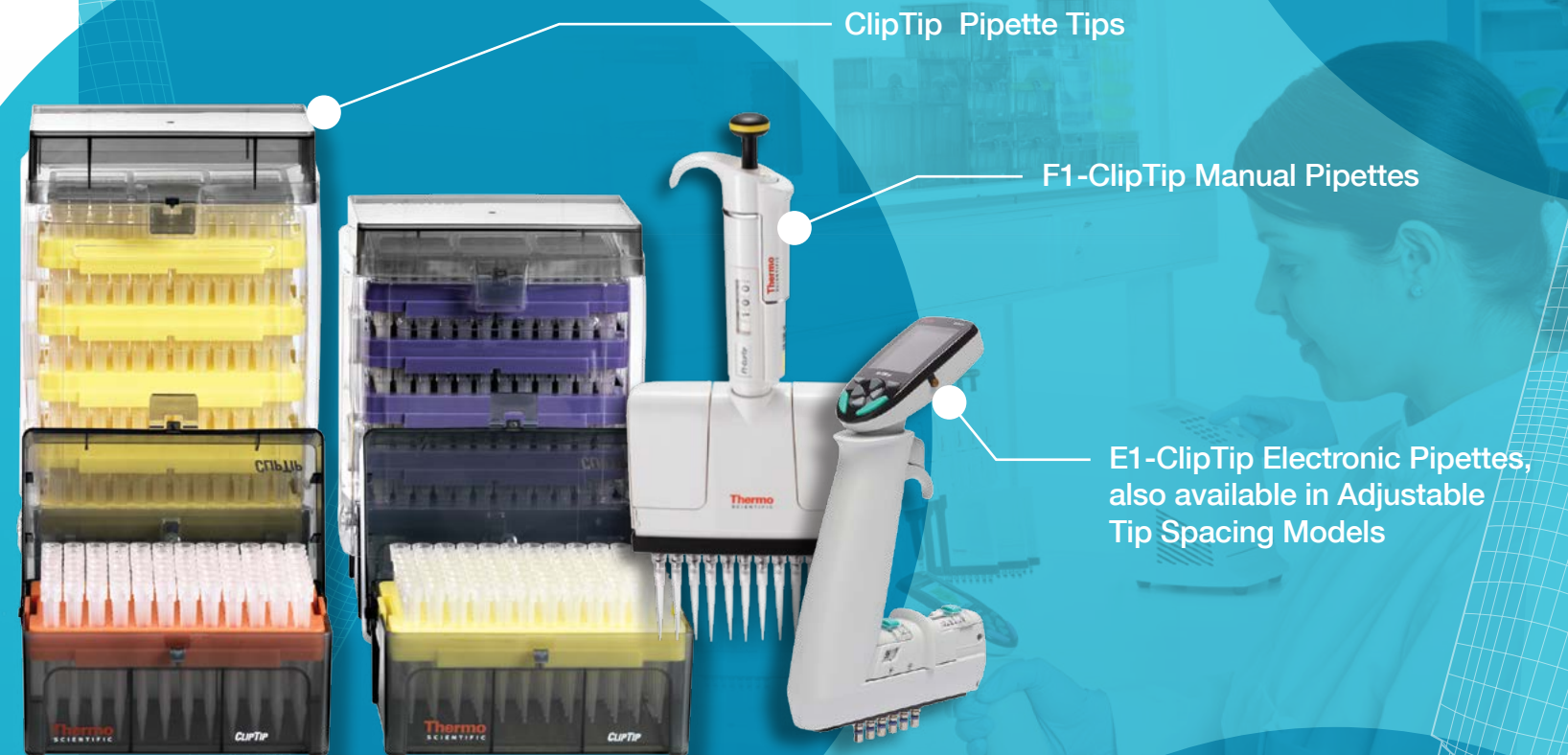

ClipTip Pipette Tips

F1-ClipTip Manual Pipettes

E1-ClipTip Electronic Pipettes,
also available in Adjustable
Tip Spacing Models

Finnpipette Pipetting System

[Download the brochure.](#)

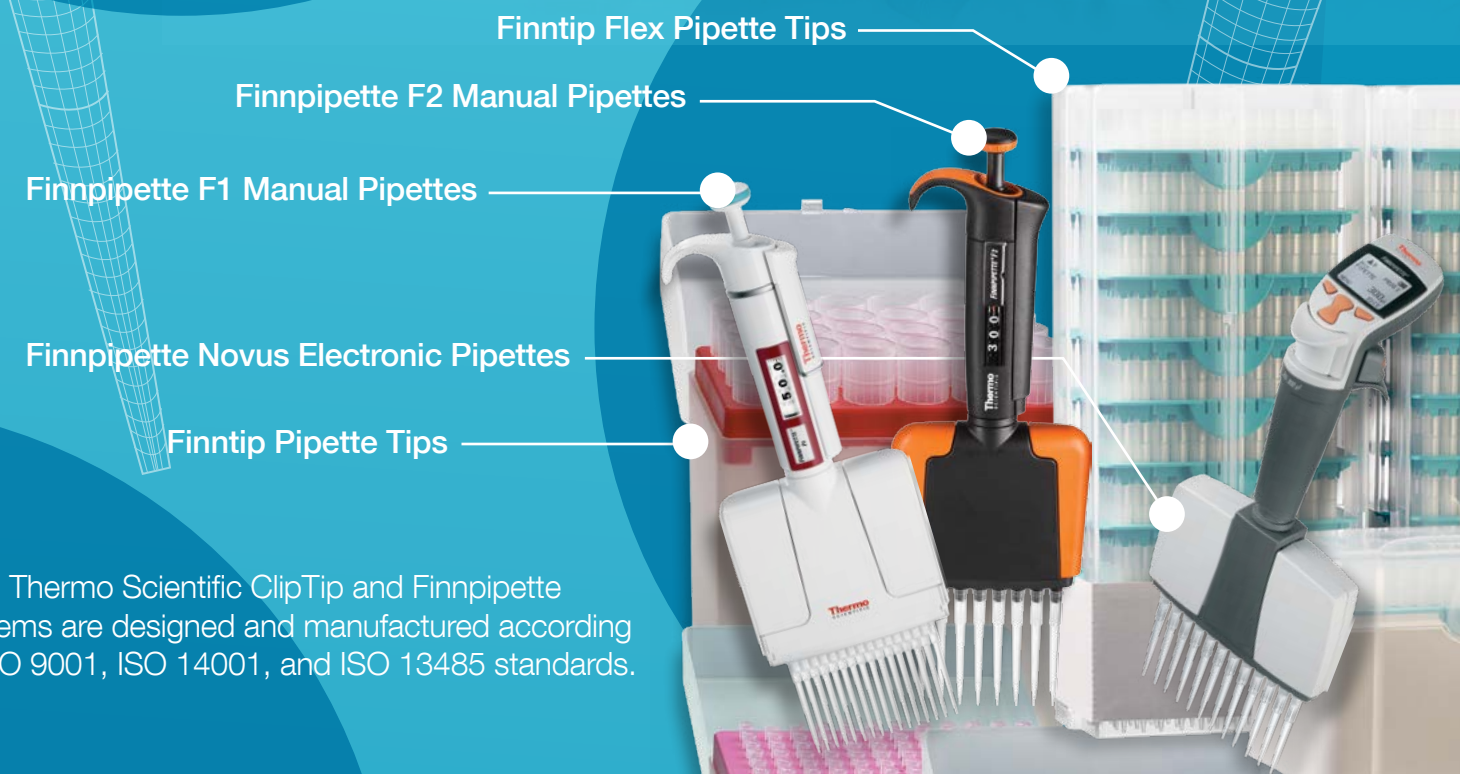

Finntip Flex Pipette Tips

Finnpipette F2 Manual Pipettes

Finnpipette F1 Manual Pipettes

Finnpipette Novus Electronic Pipettes

Finntip Pipette Tips

Both Thermo Scientific ClipTip and Finnpipette Systems are designed and manufactured according to ISO 9001, ISO 14001, and ISO 13485 standards.



Proper pipetting technique – Improve your results with proper technique



For standard pipetting use the Forward Technique:

Recommended for aqueous solutions, such as buffers, diluted acids, or alkalis, this technique is commonly used when pipetting and mixing a sample or reagent into another liquid.

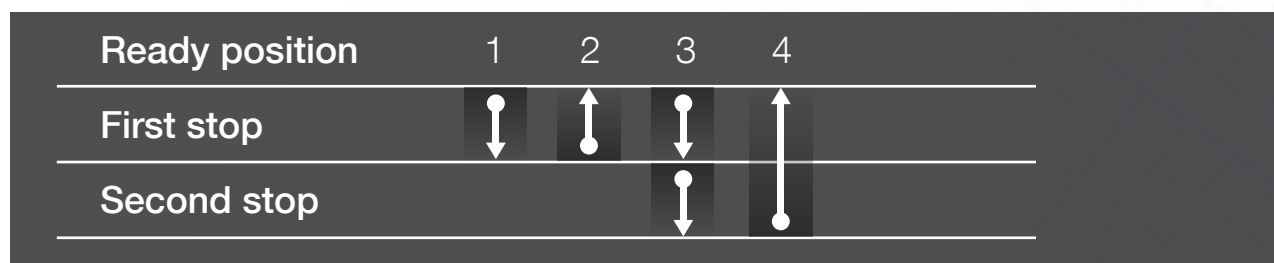

1. Press the operating button to the first stop.
2. Dip the tip into the solution to a depth of 1 cm, and slowly release the operating button. Withdraw the tip from the liquid, touching it against the edge of the reservoir to remove excess liquid.
3. Dispense the liquid into the receiving vessel by gently pressing the operating button to the first stop. After one second, press the operating button to the second stop. This action will empty the tip. Remove the tip from the vessel, sliding it along the wall of the vessel.
4. Release the operating button to the ready position.

For solutions with high viscosity or tendency to foam use the Reverse Technique:

This technique is commonly used with air displacement pipettes, and is recommended for precisely pipetting small volumes. Reverse pipetting avoids the risk of sample splash, foaming, or bubble formation.



Are you using more than 5 plates per day? Consider using Thermo Scientific Electronic pipettes, which offer a multidispensing function. This function uses a reverse pipetting technique, making it ideal for accurate and precise plate filling applications.

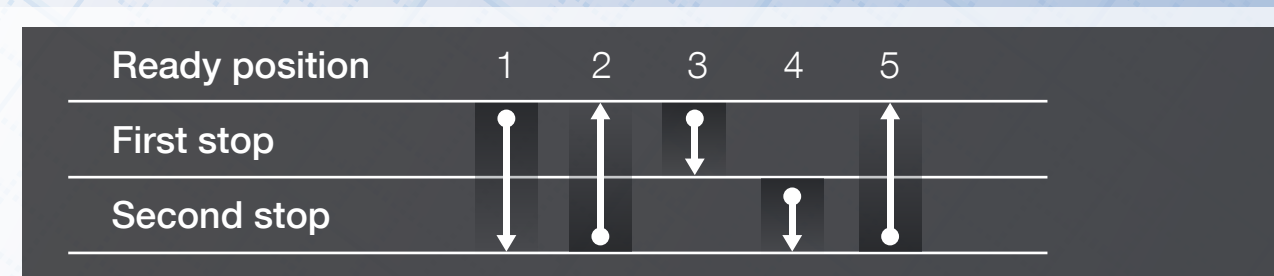

1. Press the operating button to the second stop.
2. Dip the tip into the solution to a depth of 1 cm, and slowly release the operating button. This action will fill the tip. Withdraw the tip from the liquid, touching it against the edge of the reservoir to remove excess liquid.
3. Dispense the liquid into the receiving vessel by depressing the operating button gently and steadily to the first stop. Hold the button in this position. Some liquid will remain in the tip, and this should not be dispensed. Remove the tip by sliding it along the wall of the vessel.
4. The liquid remaining in the tip can be pipetted back into the original solution or thrown away with the tip.
5. Release the operating button to the ready position.

For repeat pipetting of the same volume use the Repetitive Pipetting Technique:

This technique is intended for repeat dispensing of the same volume, and is ideal for adding reagents into tubes or wells of microplates.

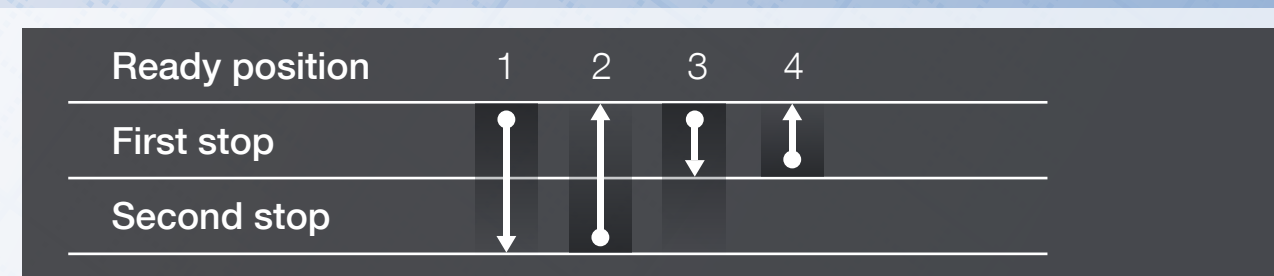

1. Press the operating button to the second stop.
2. Dip the tip into the solution to a depth of 1 cm, and slowly release the operating button. Withdraw the tip from the liquid, touching it against the edge of the reservoir to remove excess liquid.
3. Dispense the liquid into the receiving vessel by gently pressing the operating button to the first stop. Hold the button in this position. Some liquid will remain in the tip, and this should not be dispensed. Remove the tip by sliding it along the wall of the vessel.
4. Continue pipetting by repeating steps 2 and 3.



Meet Your New Favorite Pipette
Did you know that the FinnpiPETTE Novus Electronic pipettes have one click access to different pipetting techniques? **Watch the video**



Heterogeneous Sample Pipetting Technique:

This technique is used for pipetting heterogeneous samples, such as blood or serum. Typically, pre-rinsing the tip is not possible, and the full sample should be dispensed for accurate analysis.

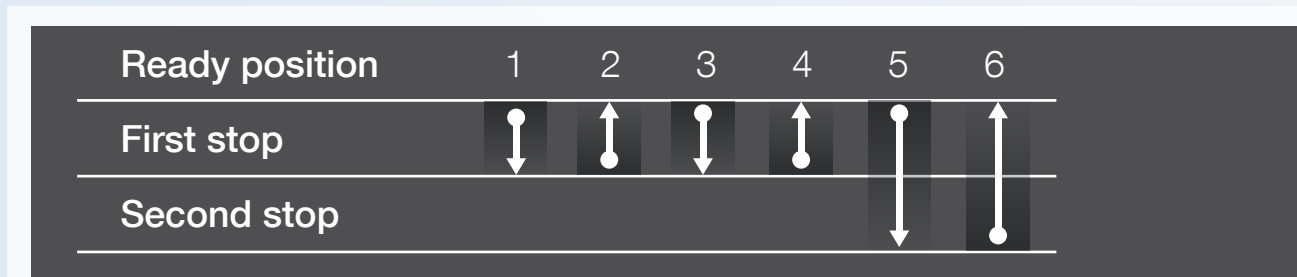

1. Press the operating button to the first stop. Dip the tip into the sample. Make sure the tip is sufficiently below the surface.
2. Release the operating button slowly to the ready position. This action will fill the tip with the sample. Remove the tip from the solution by sliding it along the wall of the vessel.
3. Dip the tip into the target solution. Make sure the tip is sufficiently below the surface.
4. Press the operating button to the first stop and release it slowly to the ready position. Do not remove the tip from the solution. Repeat this process until the interior wall of the tip is clear.
5. Remove the tip from the solution by sliding it along the wall of the vessel. Press the operating button to the second stop, and completely empty the tip.
6. Release the operating button to the ready position.

Recommendations for pipetting liquids

Getting Started

- ▶ Check your pipette at the beginning of your working day for dust and dirt on the outside. If needed, wipe with 70 percent ethanol.
- ▶ Check that you are using tips in agreement with the manufacturer's specifications. Thermo Scientific pipettes are calibrated using Thermo Scientific pipette tips.
- ▶ To ensure accuracy, use only high-quality tips made from contamination-free virgin polypropylene.
- ▶ Tips are designed for single use. They should not be cleaned for reuse, as their metrological characteristics will no longer be reliable.
- ▶ Pipette parallel samples in a similar way, e.g., pipette in the same position with the tip in the same depth, using the same speed for plunger movements.
- ▶ Avoid turning the pipette on its side when there is liquid in the tip. Liquid might get into the interior of the pipette and contaminate the pipette.
- ▶ Avoid contamination to or from hands by using a tip ejector for tip removal.
- ▶ Always store pipettes in an upright position on a stand when not in use.

Recommendations for pipetting different compounds

Solution/compound	Examples	Pipette	Pipette Tip	Pipetting technique	Comments
Aqueous solution	Buffers, diluted salt solutions	Air displacement	Standard	Forward	
Viscous solution	Protein and nucleic acid solutions, glycerol, Tween 20/40/60/80	Air displacement Positive displacement	Standard or wide orifice, Low Retention Positive displacement	Reverse	Pipette slowly to avoid bubble formation.
Volatile compounds	Methanol, hexane	Air displacement Positive displacement	Filter/Barrier Positive displacement	Reverse	Pipette rapidly to reduce the effect of evaporation. Carbon filter tips protect the integrity of the pipette by eliminating exposure to harmful vapors.
Body fluids	Whole blood, serum	Air displacement	Standard or wide orifice tip	Heterogeneous*	Residual liquid can be found on the outer surface of the tip. Wipe the tip against the edge of the vessel to remove this liquid before dispensing.
Nucleotide solutions	Genomic DNA, PCR products	Air displacement Positive displacement	Filter/Barrier or wide orifice Positive displacement	Forward	For genomic DNA wide orifice tips can be used to eliminate mechanical shearing.
Radioactive compounds	¹⁴ Carbonate, ³ H-thymidine	Air displacement Positive displacement	Filter/Barrier Positive displacement	Forward	
Acids/alkalis	H ₂ SO ₄ , HCl, NaOH	Air displacement	Filter/Barrier	Forward	
Toxic samples		Air displacement Positive displacement	Filter/Barrier Positive displacement	Forward or reverse	

*With blood or serum reverse technique is another option. During the aspiration and dispensing, use very slow plunger movements. When aspirating, hold the tips in the liquid for a few seconds, after the plunger is in the upper position. Also, when dispensing, move plunger slowly and wait a few seconds when plunger is in the down position.



Thermo Scientific FinnpiPette
Novus Electronic Pipettes



Improve Accuracy with 10 Proven Steps

1

Pre-wet the Pipette Tip

Aspirate and fully expel an amount of the liquid at least three times before aspirating for delivery. Failure to pre-wet the tip increases evaporation within the tip air space, which can cause significantly lower delivery volumes. Pre-wetting increases the humidity within the tip, thus reducing evaporation.

2

Work at Temperature Equilibrium

Allow liquids and equipment to equilibrate to ambient temperature prior to pipetting. The volume of liquid delivered by air displacement pipettes varies with relative humidity and vapor pressure of the liquid – both of which are temperature-dependent. Working at a constant temperature minimizes variation of pipetted volume.

3

Examine the Pipette Tip for Droplets

Before dispensing, carefully remove droplets from the outside of the tip by touching off the side of the reservoir, being sure to stay clear of the tip opening to avoid wicking liquid out of the tip. After dispensing, and before releasing the plunger, deliver any residual liquid remaining in the tip by touching the tip to the side of the container. Surface tension will help draw the remaining liquid out of the tip.

4

Select Forward or Reverse Pipetting Based on the Liquid

Depress the plunger to the first stop, immerse the tip into the liquid, and aspirate by releasing the plunger. Remove the pipette from the liquid and depress the plunger to the second stop to dispense the entire contents. Standard (or forward) mode pipetting yields better accuracy and precision than reverse mode for all but viscous or volatile liquids. Reverse mode often results in over-delivery. Hence, it's recommended to evaluate the effect of possible over-delivery in the experiment and make adjustments if needed.

Effect of Temperature

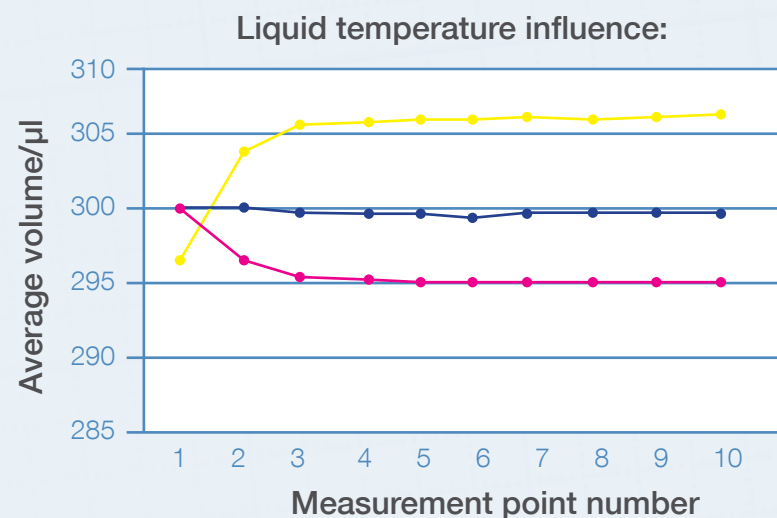

Temperature differences cause thermal expansion and shrinking in the air space. After temperature equilibrium, the influencing factor is liquid density. Cold liquid is more dense and hot liquid is less dense compared to room temperature liquids.

- Room temperature
- 15 °C/59 °F
- 30 °C/86 °F

Effect of Viscosity

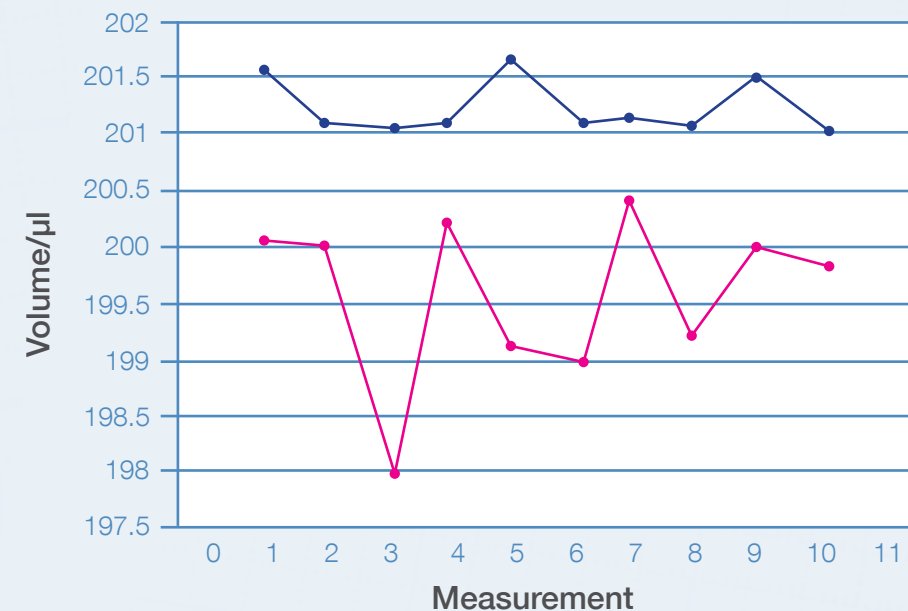

In this experiment 200 µl of viscous liquid (glycerol) was pipetted 10 times by using both forward and reverse pipetting techniques. The pipette used was adjusted for glycerol using forward pipetting. The chart describes the accuracy and precision obtained with both techniques.

Using the reverse method a smaller deviation between doses was observed and therefore reduced imprecision.

The reverse method gave bigger doses as the liquid column in the tip is taller and therefore the liquid amount above the dose presses a larger dose out.

- Forward method
- Reverse method



5

Pause Consistently

After aspirating, and before removing the tip from the liquid, pause for one second. Make this pause as consistent as possible. Liquid continues to flow into the tip for a short time after the plunger stops. At the same time, evaporation within the tip is occurring. Pausing consistently balances these two effects and ensures correct aspiration.

6

Remove Pipette Straight from Vessel

When aspirating liquid, hold the pipette vertically and pull the pipette straight out from the center of the reservoir. This technique is especially important when pipetting small volumes (less than 50 µl). Holding the pipette at an angle as it is removed from the liquid alters the aspirated volume.

7

Minimize Handling of Pipette and Tip

Hold the pipette loosely and utilize the finger rest. Remember to return the pipette to the pipette stand between deliveries. Avoid handling pipette tips or reservoirs with bare hands. Body heat transferred during handling disturbs temperature equilibrium, which leads to variations in delivered volume.

8

Use the Correct Immersion Depth

Before aspirating, immerse the tip adequately below the meniscus. Too little immersion, particularly with large volume pipettes, can lead to aspiration of air. Too much immersion can cause liquid to cling to the outside of the tip. Contacting the container bottom with the tip may restrict aspiration.

Tip Immersion Depth and Angle

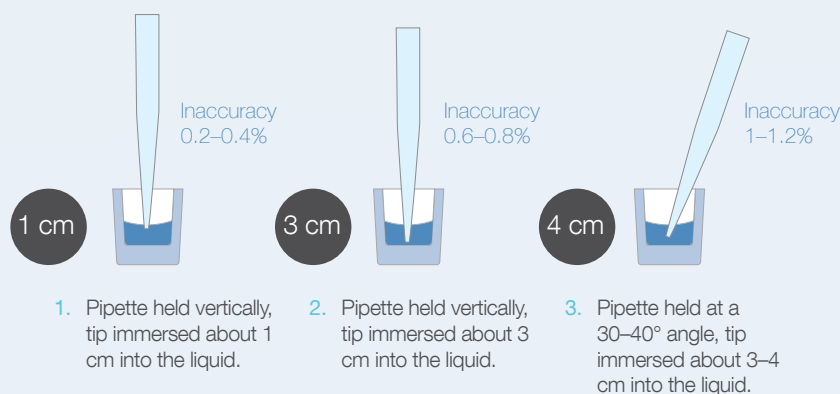

Effects of immersing the tip too deeply and tilting the pipette are greater with small sample volumes, e.g., using 1–10 µl pipette.

Step 1: The tip is immersed to the correct depth and correctly held vertically.

Step 2: Inaccuracy doubles when immersing the tip too deeply.

Step 3: Inaccuracy increases three to five times by immersing too deeply while holding the pipette at a 30–40° angle.

9

Use the Correct Pipette Tip

Use high-quality tips intended for use with the pipette. System tips are designed to work with their matching pipettes. Mismatched tips and pipettes can result in inaccuracy, imprecision, or both. Quality system tips provide an airtight seal, are made of superior materials, and are free of molding defects. They also ensure dependable liquid delivery.

Understanding Tip Quality

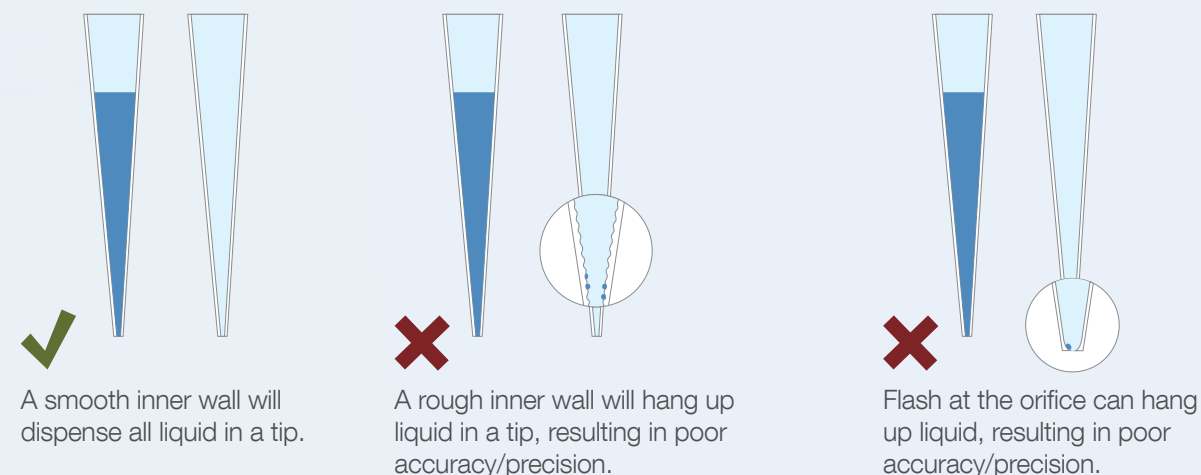

10

Use Consistent Plunger Force and Speed

Depress the plunger smoothly until coming to rest with a light and consistent force at the first stop. Immerse the tip, and then release the plunger at a constant rate. Repeatable actions produce repeatable results.

Did you know it's possible to adjust aspiration and dispensing speeds for each pipetting step separately with E1-ClipTip Electronic pipettes?

Combine this feature with electronic pipetting action to minimize any personal effects on your protocol for optimal and consistent liquid dispensing.





Accurate Data. More Discoveries.

Accuracy is the quality of being true, correct, exact, and free from error. Accuracy is the ability of a pipette to give a response close to a true or nominal volume as indicated by the volume setting.

Precision is often referred to as repeatability or sample reproducibility, and also as a standard deviation.

Error-free pipetting requires both precision and accuracy.
When pipettes are both accurate and precise the mean volume is the set volume and there is no variation between different pipettings.

Example: The pipette volume is set at 20 μl .

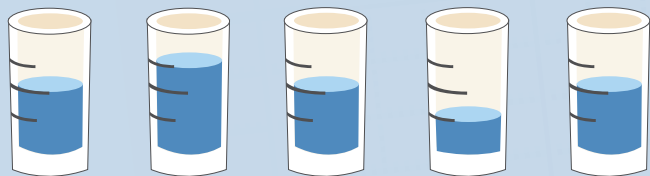

Accurate, but not precise:

The mean volume is the correct (set) volume, but the separate pipettings differ from the set volume.



Precise, but not accurate:

There is no variation between the separate pipettings, but the mean volume differs from the set volume.

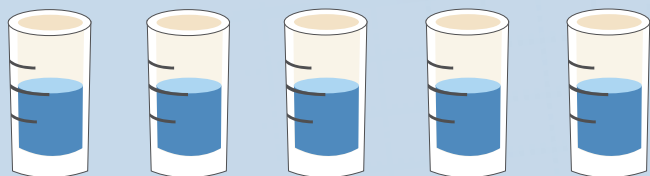

Accurate and precise:

The mean volume is the set volume, and there is no variation between the different pipettings.

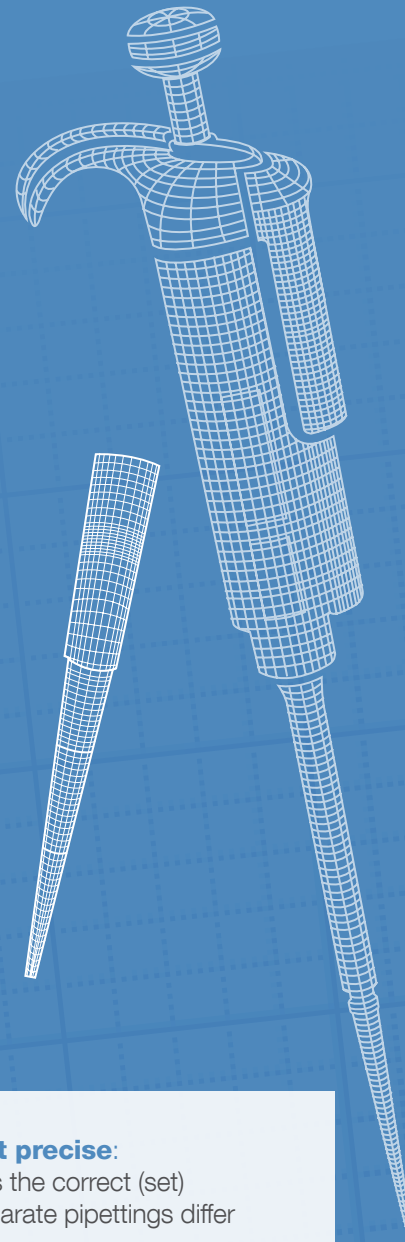

Factors Affecting the Accuracy of Air Displacement Pipettes

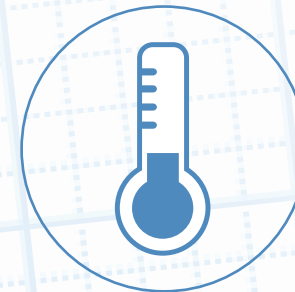

Temperature

Temperature has many effects on pipetting accuracy. The factor that has the greatest effect is the temperature difference between the delivery device and the liquid. The air gap (dead air volume) between the liquid surface and the piston experiences thermal expansion effects unique to the case. This either reduces or increases the liquid amount aspirated into the tip, along with other effects.

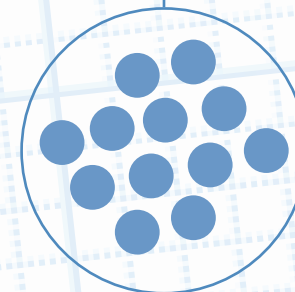

Density

The density (mass/volume ratio) affects the liquid volume that is aspirated into the tip. A smaller dose of liquid with higher density than water is aspirated compared to a similar operation with water. With lower density liquids the effect is the opposite. This is caused by the flexible dead air volume along with earth's gravity. The density of liquids also varies according to temperature. Typically the density for water is 0.998 kg/dm^3 , for ethanol 0.79 kg/dm^3 , and for sulfuric acid (95–98% H_2SO_4) 1.84 kg/dm^3 (the values apply at the temperature of 20 $^\circ\text{C}/68$ $^\circ\text{F}$).



Altitude

Geographic altitude affects accuracy through air pressure. Air pressure decreases in higher altitudes, and the conversion factor Z decreases as well. Also, with some liquids, the boiling point decreases quite close to room temperature, which will increase the evaporation loss dramatically.



Ergonomics – Ensure your daily environment fits you comfortably

“Work-related musculoskeletal disorders...are the most prevalent, most expensive, and most preventable workplace injuries in the country. The good news is that real solutions are available”

Alexis M. Herman
Former U.S. Secretary of Labor
United States Occupational Safety and Health Administration. 'One size doesn't fit all' (1999)

Ergonomics is the study of how to arrange and design devices, machines, or workspace so that people and things interact safely and efficiently. Ergonomics is also called human factors analysis or human factors engineering. As noted by Occupational Safety and Health Administrations (OSHA) Federal and State Programs, ergonomics is essentially “the science of fitting the job to the worker.”

Poor ergonomics can result in musculoskeletal disorders (MSD). MSD is also known as cumulative trauma disorders (CTD), repetitive strain injuries (RSI), and work related upper limb disorders (WRULD); these all refer to injuries to muscles, nerves, tendons, ligaments, joints, and cartilage resulting from repetition, excess force, inadequate rest, etc.

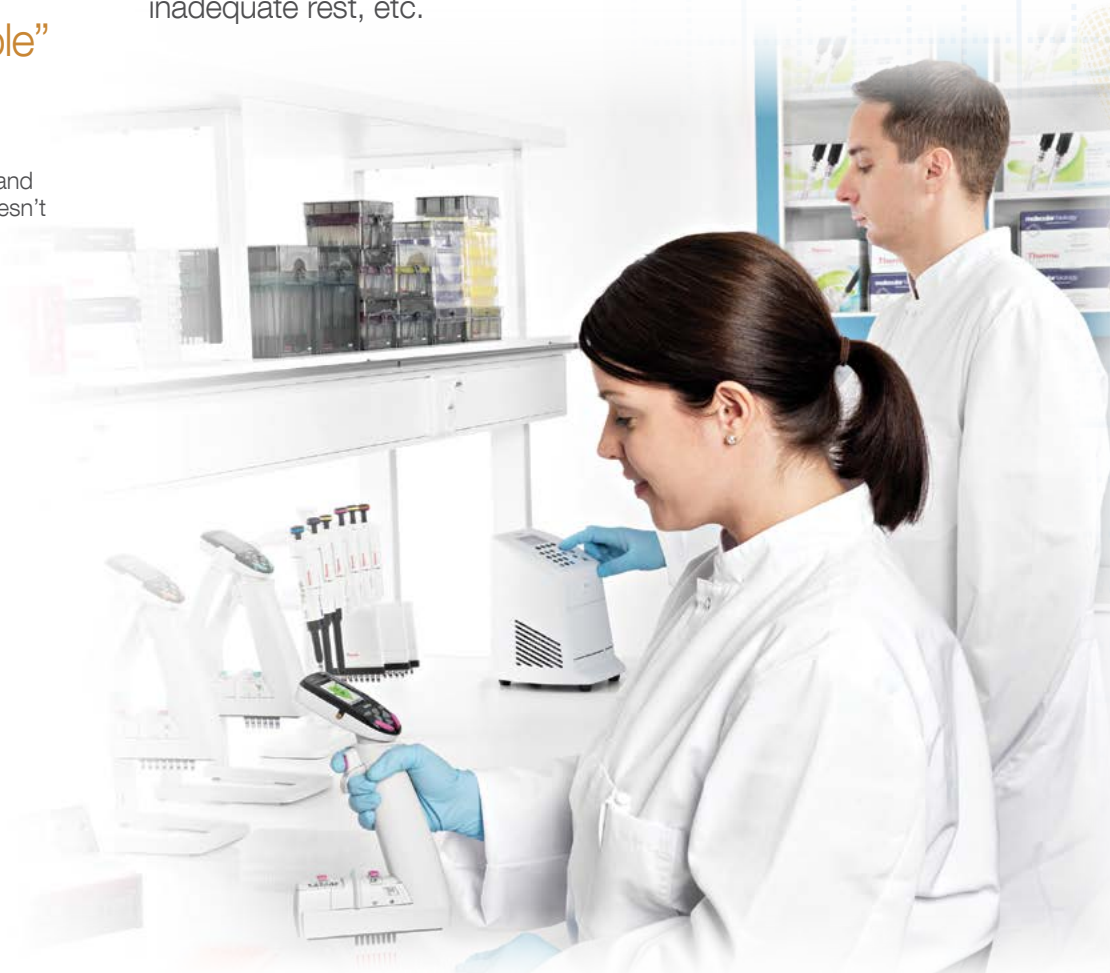

“Laboratory personnel spend roughly 2 hours a day on average on pipetting, which amounts to 500 hours a year. Bjorksten concluded that more than 1.3 hours a day elevated the risk of injury.”

Bjorksten, Almby, and Jansson; 'Hand and shoulder ailments among laboratory technicians using modern plunger-operated pipettes' 1994 . Thirty minutes of continuous pipetting can cause increased hand complaints: David, Buckle; A questionnaire survey of the ergonomic problems associated with pipettes and their usage with specific reference to work-related upper limb disorders. Applied Ergonomics. 1995; 28 (4): 257-62. Typical Laboratories can perform thousands of pipetting operations a day.

Reduce Pipetting Risk Factors

- ▶ **Environment** - position surrounding materials to enable proper posture
- ▶ **Posture** - correct positioning of your body by using the correct tools
- ▶ **Force** - reducing the tip attachment, ejection, and pipetting force required in daily activities
- ▶ **Repetition** - limit the number of pipetting motions

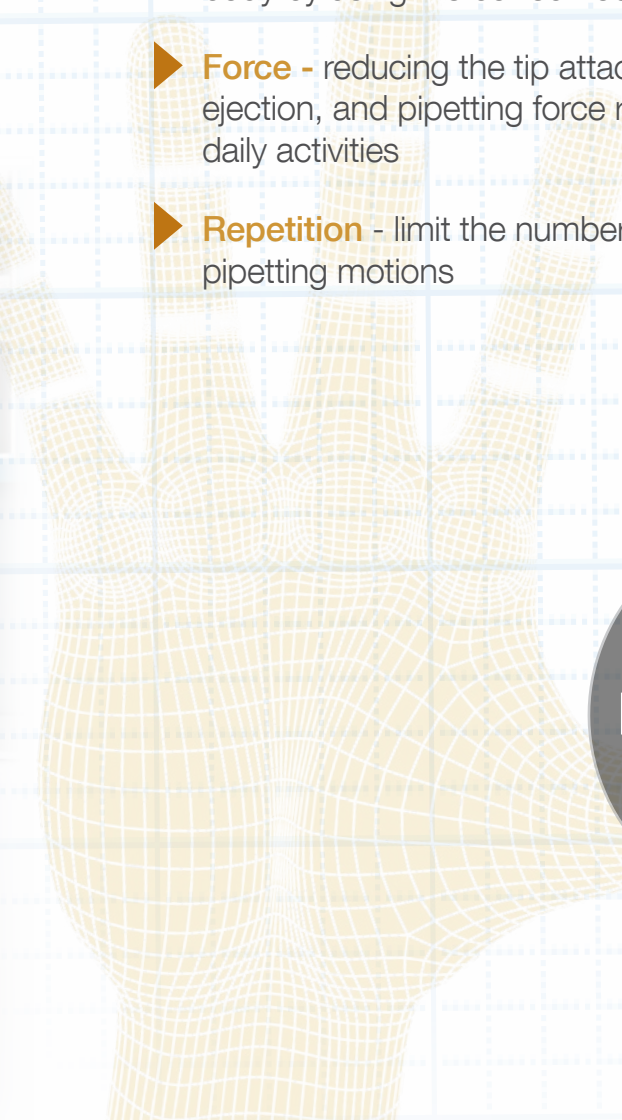
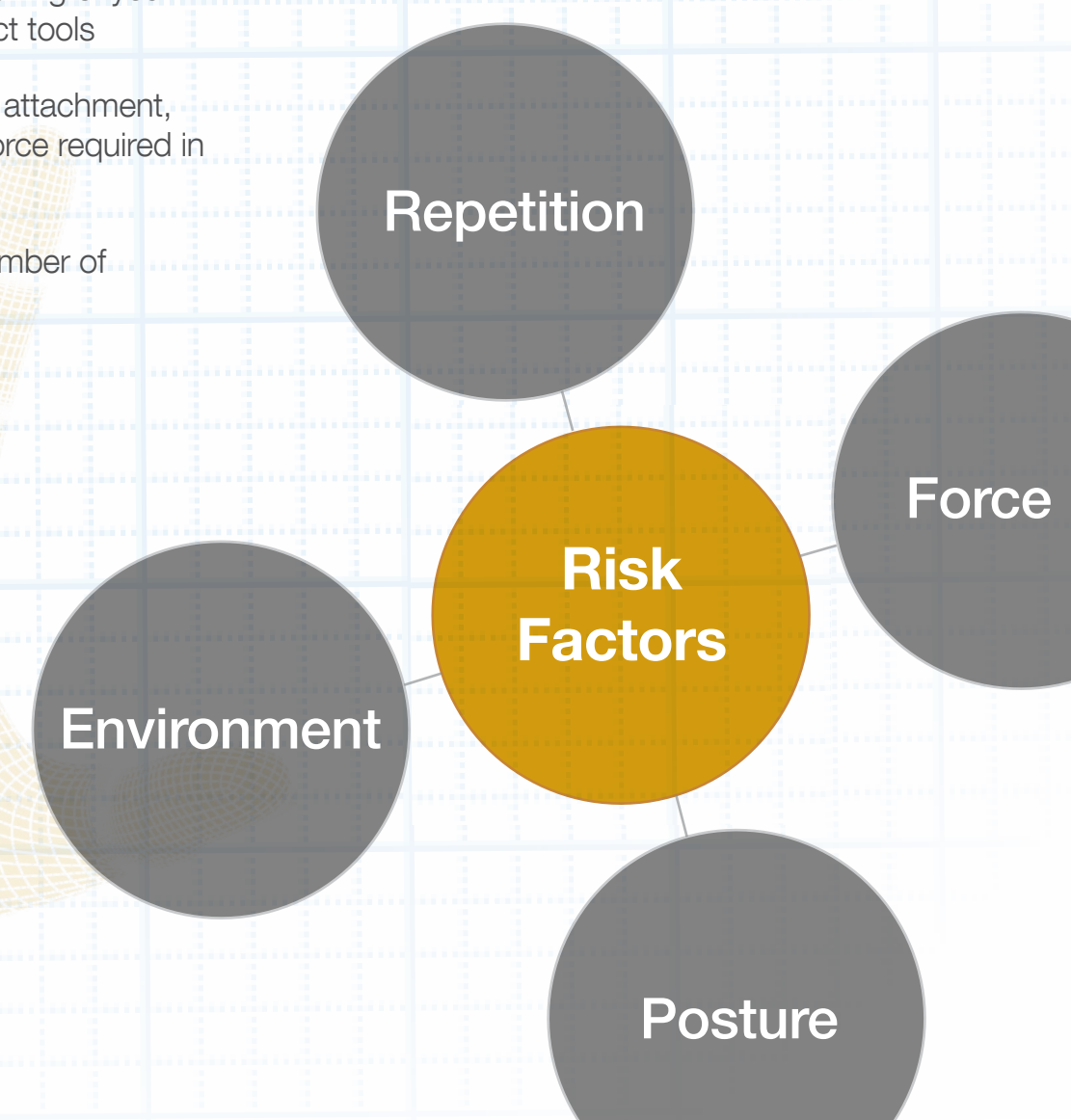

Environment



- 1 Take micro-breaks of 3-5 minutes, for every 20-30 minutes of pipetting
- 2 Adjust the workstation so the work can be done with arms close to the body
- 3 Use shorter pipettes
- 4 Use pipettes that fit comfortably in the user's hand
- 5 Keep samples and instruments within easy reach
- 6 Use low profile waste receptacles for used tips
- 7 Use anti-fatigue matting when it's necessary to stand for long periods of time
- 8 Use an adjustable stool or chair when sitting

Posture

Bad Posture



Seated posture:

- Shoulders elevated
- Upper arm elevated
- Elbow extended
- Wrist in deviation



Standing posture:

- Upper back and neck slumped
- Lower back and trunk slumped
- Elbow flexed

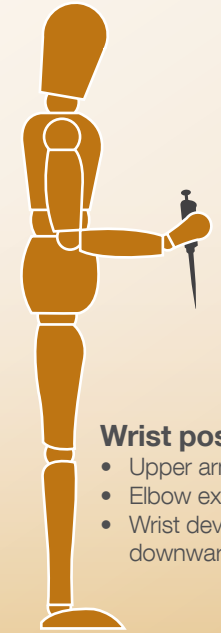

Wrist posture:

- Upper arm flexed
- Elbow extended
- Wrist deviated downward

Good Posture



Seated posture:

- Lower back supported by chair
- Upper back and neck upright
- Upper arm vertical
- Wrist in the same plane as the forearm



Standing posture:

- Lower back and neck upright
- Upper back and neck upright
- Upper arm vertical
- Elbow bent at 90°
- Forearm parallel to the floor
- Wrist in the same plane as the forearm



Wrist posture:

- Forearm parallel to the floor
- Wrist and forearm in the same plane



WATCH how ClipTip Technology works

Force

Conical shaped pipettes and tips

The proximal end of a standard pipette tip is usually conical. The conical shaped pipette cone fits into the conical shaped pipette tip. This force creates a 'Luer' seal which can result in high friction. The sealing area is typically large. The ejection force is proportional to insertion force.

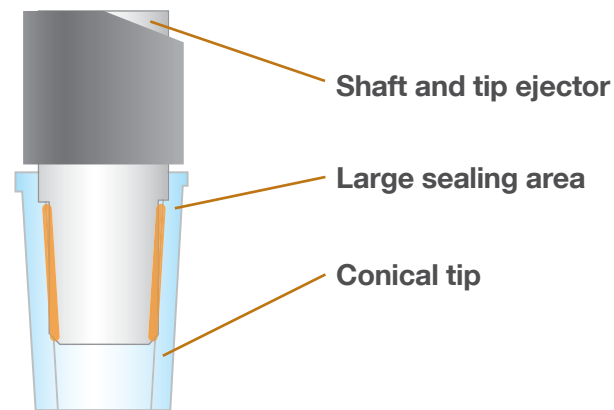

ClipTip Interlocking Pipetting System

ClipTip pipette tips lock firmly in place so they will not loosen or fall off, regardless of application pressure. You can actually feel the tips 'clip' securely onto the pipette with a light touch. No more banging tips on your pipette to ensure that the tips are properly attached and sealed.

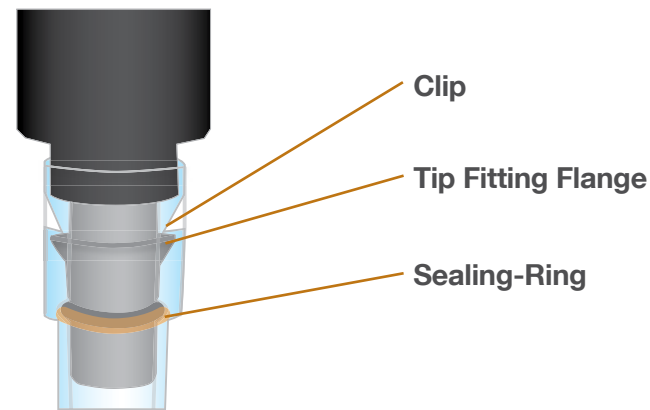

Sealed in Security. Feel the Difference.

Attachment Forces F1-ClipTip Manual Pipettes vs. Other Pipettes



Ejection Forces F1-ClipTip Manual Pipettes vs. Other Pipettes

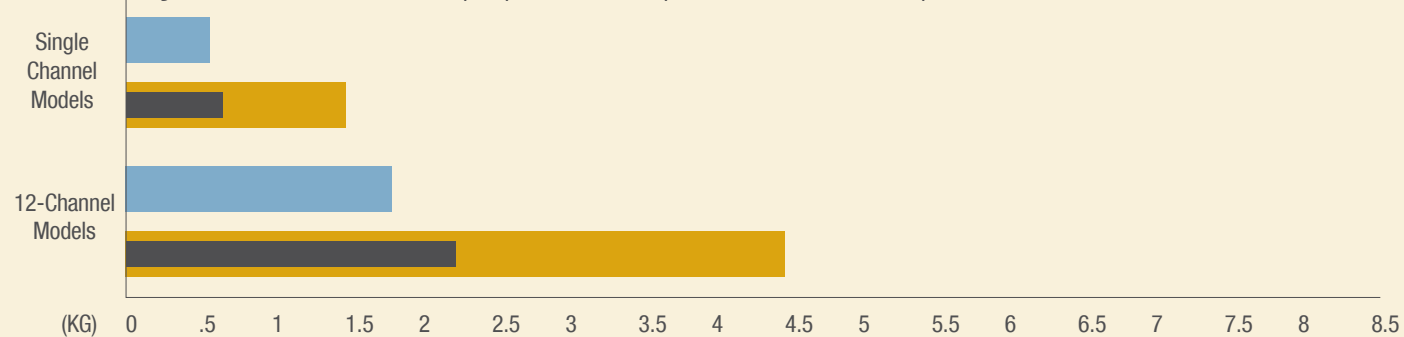

■ F1-ClipTip pipettes ■ Manufacturer B pipettes ■ Manufacturer C pipettes

The F1-ClipTip Pipetting system provides a significant reduction in tip attachment and ejection forces compared to traditional friction-based systems

Repetition

Reduce tiresome pipetting repetitions with E1-ClipTip Equalizer Electronic Pipettes.

Increase efficiency and quality with adjustable tip spacing, which enables multiple sample transfers between virtually any tube, rack, microplate, or horizontal gel box at once. Just set the distance between the tips simply by sliding the scale to expand and contract to your desired setting.

96-Format E1-ClipTip Equalizer Adjustable Tip Spacing Pipettes

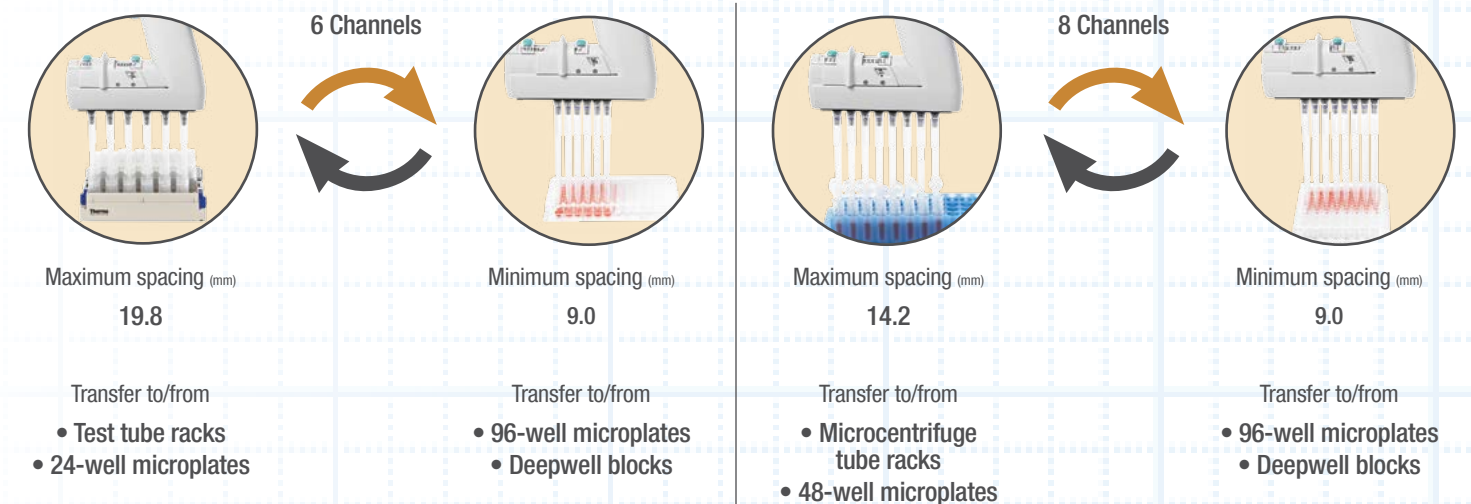

384-Format E1-ClipTip Equalizer Adjustable Tip Spacing Pipettes

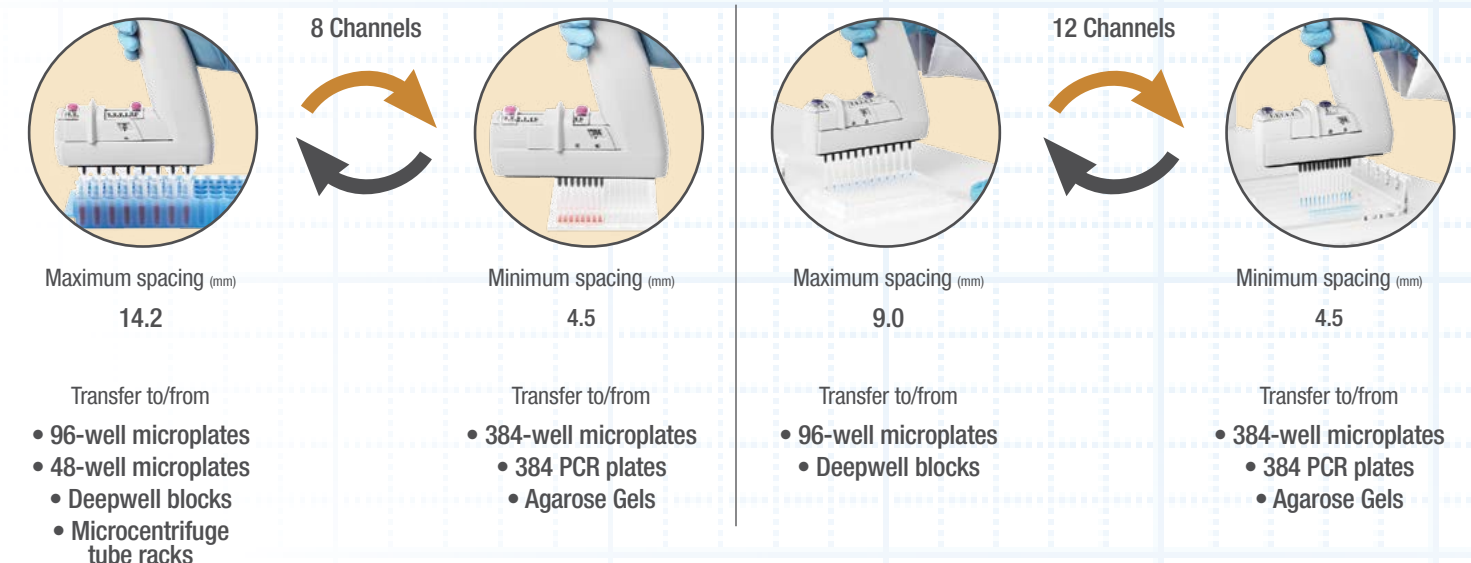

Over 90% time savings and less repetitions compared to single channel pipettes*
READ MORE >>

*Compared to a manual single channel pipette filling a 96-well microplate from microcentrifuge tubes.



Maintenance and service – Secure the quality of your results

Tailored solutions to fit your unique needs: Pipette Calibration, Preventive Maintenance, and Repair Services

Pipette cleaning

We make it easy for you to maintain pipette performance over time, and to demonstrate GLP/GMP compliance by offering fast, expert-level calibration, preventive maintenance, and repair services for all Thermo Scientific pipettes, and for most other brands as well. Experienced service personnel are highly trained in all pipette models. We offer both standard and custom service packages to meet the needs of individual customers, and in most major markets we have the ability to bring our calibration, preventive maintenance, and repair services (minor repairs) directly to your facility. (Note: On-site service availability varies between countries. Minimum quantities apply, please check website for details).

Calibration of Pipettes in a Quality System

The main objective of pipette calibration in a quality system is to ensure that dispensing is carried out with the intended accuracy. Very often the error limits are taken from the manufacturer's specifications, although far less accuracy is needed to perform the task. It should be kept in mind that in a laboratory environment (uncontrolled) the manufacturer's specifications may not be achieved. Therefore, every user should define their own acceptance limits, according to the application and the ambient conditions. Another option is to use the acceptance limits stated in the standards, for example, EN ISO 8655 multiplied by two. The actual standard specifications—and if the highest accuracy is needed, the manufacturer's specifications—should be used only when testing can be performed in a controlled environment using distilled or deionized water.

Procedure to Check Calibration

The pipette is checked with the maximum volume (nominal volume), and the minimum volume, and/or 10 percent of the maximum volume, whichever is higher. For example, Thermo Scientific Finnpiquette 0.5–10 μl is tested at 1 μl and 10 μl . A new tip is first pre-wetted 3–5 times and a series of 10 pipettings is performed with both volumes. With multichannel pipettes, both volumes are tested with the two edge channels. A pipette is always calibrated for delivery (EX) of the selected volume. If the calculated results are within the selected limits, the adjustment of the pipette is correct.

Maintenance Intervals

Service intervals vary depending on how often the pipette is used and the liquids that are pipetted. Below are guidelines for frequency of servicing your pipette.

Daily Service Procedure

It is recommended that the pipette be checked at the beginning of each day for dirt and dust. To clean a dirty pipette, wipe the surface with a sponge moistened with disinfectant. Particular attention should be paid to the tip cone, which tends to come into contact with the pipetted liquid. The handle does not require further service and should not be immersed in disinfectant.

Pipettes should always be stored in an upright position to prevent residual liquid from entering into the tip cone. A pipette stand is ideal for this purpose.

Defining Calibration and Preventive Maintenance

Calibration of pipettes means determining the difference between the dispensed volume and selected volume. Adjustment means altering the pipette so the dispensed volume is within the specifications.



To learn more about Unity Lab Services Pipette Support Plans in your region, contact your local sales representative, or visit www.unitylabservices.com/pipette



Did you know we have service reminders?

You can set your E1-ClipTip Electronic Pipettes service and calibration reminders or we will send email reminders for your selected times when you register online for extended warranties.



Periodic Service Procedures

If the pipette is used daily, it should be cleaned and lubricated at least every three months. The service procedure starts with the disassembly of the pipette. Detailed instructions for the disassembly can be found in the Instructions for Use. The calibration must always be checked after cleaning. Some chemicals, such as organic solvents, affect certain parts of the pipette. Therefore, when pipetting these chemicals frequently, special attention should be paid to service.

Vapors from organic solvents may cause the O-rings to swell. When pipetting organic solvents frequently, open the lower part of the pipette and leave it open overnight to ensure proper airing. The O-rings should also be checked and lubricated weekly, and replaced if necessary to prevent leaking. Aerosols from acids and alkalis, on the other hand, affect greasing. Therefore, when pipetting acids and alkalis frequently, it is important to lubricate the piston, piston spring, and the O-rings regularly. Do not use any lubricant to grease the pipette other than the one provided with the pipette.

Filter tips are the best way to keep your pipette clean and protect both your pipette and the sample from contamination. The filter prevents aerosols as well as excess liquids or foreign particles from entering the pipette.

Formulas for calculating results

Conversion of mass to volume

$$V = (w + e) \times Z$$

V = Volume (μl)

w = Weight (mg)

e = Evaporation loss (mg)

Z = Conversion factor for mg/ μl conversion

Evaporation loss can be significant with low volumes. To determine mass loss, dispense water into the weighing vessel, note the reading, and begin timing with a stop watch. Check how much the reading decreases during 30 seconds. Compare this to the pipetting. Typically, the pipetting time might be 10 seconds and the mass loss is 2 mg. If an evaporation trap or lid on the vessel is used, an evaporation correction is unnecessary.

The conversion factor Z is for calculating the density of water suspended in air at a test temperature and pressure. **Download the conversion table.**

Accuracy (systematic error)

Accuracy is the difference between the dispensed volume and selected volume of a pipette.

$$A = \bar{V} - V_0$$

A = Accuracy

\bar{V} = Mean volume

V_0 = Target volume

Accuracy can be expressed as a relative value:

$$A\% = 100\% \times A/V_0$$

Precision (random error)

Precision refers to the repeatability of the pipettings. It is expressed as standard deviation(s) or coefficient of variation (cv). In addition to the features of the pipette, laboratory practice and user experience are the main factors that affect precision.

$$s = \sqrt{\frac{\sum_{i=1}^n (V_i - \bar{V})^2}{n-1}}$$

s = Standard deviation

\bar{V} = Mean volume

n = Number of measurements

V_i = Single measurement result ($i = 1 \dots n$)

Standard deviation can be expressed as a relative value as cv.

$$CV = 100\% \times s/\bar{V}$$



Did you know that it's possible to create liquid specific calibrations with the E1-ClipTip electronic pipette?



READ MORE about the benefits of routine pipette preventive maintenance and calibration



Decontamination Guidelines

Definitions*

- ▶ **Decontamination** – Any process for removing and/or killing microorganisms. The same term is also used for removing or neutralizing hazardous chemicals and radioactive materials.
- ▶ **Disinfection** – A physical or chemical means of killing microorganisms, but not necessarily spores.
- ▶ **Sterilization** – A process that kills and/or removes all classes of microorganisms and spores.

Pipette cleaning

Cleaning requirements depend on the pipette used and the liquid. The chemical compatibility of the pipette should be checked prior to cleaning. When necessary, protective clothing, goggles, and disposable gloves should be worn.

Table 1. Cleaning guidelines for Thermo Scientific manual pipettes. See Instructions for Use for Electronic Pipettes guidelines.

Pipetted liquids	Cleaning guidelines
Aqueous solutions and buffers	Open the pipette, rinse the contaminated parts thoroughly with distilled water, and allow to dry.
Acids and alkalis	It is advisable to clean the tip cone and lower part of the tip ejector with distilled water more frequently if acids or alkalis are handled. Clean as described in "Aqueous solutions and buffers."
Organic solvents	Immerse the contaminated parts in a detergent solution such as Deconex® 12 Basic. Rinse thoroughly with distilled water and allow to dry.
Radioactive solutions	Open the pipette and place the contaminated parts in a strong detergent or cleaning solution. Rinse several times with distilled water and allow to dry. Decontamination should always be followed by confirming that radioactivity has been reduced to an acceptable level. All used cleaning materials are radioactive waste and must be disposed of according to regulations.
Proteins	Open the pipette, immerse the parts in a detergent solution, such as Deconex® 12 Basic. Rinse well with distilled water and allow to dry.
DNA, RNA	<ul style="list-style-type: none"> • DNA can be eliminated by immersing pipette parts in at least 3% (w/v) sodium hypochlorite for at least 15 minutes (2, 3). Rinse well with distilled water and allow to dry. • Treat the pipette parts with Thermo Scientific DNA AWAY Surface Decontaminates according to instructions. • Exposure to ultraviolet (UV) light for 30–60 minutes will further reduce but not completely eliminate DNA contamination on the pipette surface (4). • No special treatment is required to remove RNA because it degrades rapidly and is sensitive to ubiquitous RNases.
DNase, RNase	<ul style="list-style-type: none"> • RNase can be removed by first cleaning the pipette with a detergent solution, followed by thoroughly rinsing with water and then 95% ethanol to speed the drying process. Pipette parts are then soaked in a 3% hydrogen peroxide solution for 10 minutes. Finally, the parts are rinsed thoroughly with DEPC-treated water (5) and allowed to dry. • Treat the pipette parts with Thermo Scientific RNase AWAY Surface Decontaminates according to instructions. • DNase can be destroyed by autoclaving (15 min., 121 °C/250 °F).
Viruses, mycoplasma, bacteria, and fungi	Ultraviolet (UV) radiation is a practical method for inactivating viruses, mycoplasma, bacteria, and fungi. If the inner parts of the pipette are exposed to UV light, make sure the piston and O-rings are sufficiently lubricated.

Before assembling the pipette, wipe the piston with 70% ethanol and lubricate with the lubricant that is provided with the pipette. When removing RNase, use a freshly opened ethanol bottle and prepare 70% ethanol in DEPC treated water.

Pipette sterilization

Autoclaving is the simplest sterilization method if all pipette parts tolerate extreme heat. Pipettes should be autoclaved according to the manufacturer's instructions. To achieve sterility, a holding time of at least 20 minutes at 121°C (252°F) is required.

- Fully autoclavable Finnpiptette F2 and Digital manual pipettes
- Autoclavable tip cones: F1-ClipTip, Finnpiptette F1, F3, and Novus pipettes (see Instructions for Use).

All Thermo Scientific manual pipettes can be sterilized with STERRAD® and ethylene oxide treatments. The pipette should be disassembled before the sterilization treatment.

Chemical disinfection and sterilization

Chemical disinfectants or sterilants are used to decontaminate surfaces and equipment if autoclaving is not possible or practical. The choice of a chemical disinfectant or sterilant depends on the microorganisms of concern. Also, the chemical compatibility of the materials should be taken into account. Examples of chemical disinfectants or sterilants are listed in Table 2.

If the lower tip cone and the tip ejector of a pipette have to be chemically decontaminated, the pipette should be disassembled according to the Instructions for Use.

Table 2. Examples of chemical disinfectants and sterilants

	Disinfection time (at 20°C/68°F)	Sterilization time (at 20°C/68°F)
Hydrogen peroxide (7.5%)	30 minutes	6 hours
Glutaraldehyde (2.5%)	20–90 minutes	10 hours
Sodium hypochlorite (5%)	20 minutes	N/A
Ethanol (70%)	10–30 minutes	N/A

Preventing Cross-contamination

Pipette-to-sample

A contaminated pipette or contaminated tips can cause contamination of samples.

Prevention:

- ▶ Use filter tips.
- ▶ Change the tip after pipetting each sample.
- ▶ Clean the pipette regularly.

Sample-to-pipette

Samples or aerosols from samples can enter the cone of the pipette.

Prevention:

- ▶ Keep the pipette vertical when pipetting in order to prevent liquid from running into the pipette body.
- ▶ Release the push button slowly.
- ▶ To avoid aerosol contamination, use filter tips or use a positive displacement pipette and tips.

Sample-to-sample (carry-over)

The remains of a sample can mix with the next sample inside the tip and may cause a false test result.

Prevention:

- ▶ Change the tip after each sample.
- ▶ If you suspect your pipette is contaminated, clean with a suitable method, and autoclave if needed.

* Definitions comply with the WHO Laboratory biosafety manual (1).

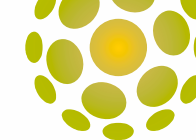

References

1. World Health Organization, 2004. Laboratory biosafety manual. 3rd edition. Geneva, Switzerland.
2. Kemp, B.M. and D.G. Smith, 2005. Use of DNase to eliminate contamination in ancient DNA analysis. *Forensic Sci. Int.* 10 (154), pp. 53-61.
3. Prince, A.M. and L. Andrus, 1992. PCR: How to kill unwanted DNA. *Biotechniques* 12 (3), pp. 58-60.
4. Cone, R.W. and M.R. Fairfax, 1993. Protocol for ultraviolet irradiation of surfaces to reduce PCR contamination. *Genome Research* 3, pp. S15-S17.
5. Sambrook, J., E. F. Fritsch and T. Maniatis, 1989. Extraction and purification of RNA. In: *Molecular Cloning – A Laboratory manual*, 2nd edition. Cold Spring Harbor Laboratory Press, New York.

Links

“Lab Workers - Take the Pain Out of Pipetting,” Published by California Dept of Health Services, Occupational Health Branch. Available at <http://www.cdph.ca.gov/programs/hesis/Documents/labwork.pdf>

“Reducing the Risk of Musculoskeletal Injury in Healthcare Laboratory Technologists Performing Pipetting Tasks,” Published by Occupational Health & Safety Agency for Healthcare, British Columbia. Available at <http://www.phsa.ca/Documents/Occupational-Health-Safety/ProjectUpdateReducingtheRiskofMusculoskeletalInjur.pdf>

“Tips for Pipetting,” Published by UCLA Environment Health and Safety. Available at <http://ergonomics.ucla.edu/laboratory-ergonomics/tips-for-pipetting.html>

Enable the Smart Lab

Focus on doing the science you need to do. The way you want to do it. Making it easier to do your job, lower costs, and get your results faster. We think that's smart.



For more information on Thermo Scientific Liquid Handling Solutions to enhance your daily pipetting visit: thermoscientific.com/handleanything

Unity[™] Lab Services

Part of Thermo Fisher Scientific

Protecting your investment

To improve your laboratory's efficiency, you should be free to focus on your work, not burdened by managing instrument service. We provide a complete portfolio of customized, integrated, and innovative services and support solutions designed to help you improve productivity, reduce total cost of ownership, and ensure compliance throughout your laboratory — from instrument and equipment acquisition to disposition.

Let our expertise complement yours

Explore all the new ways to protect your instruments and equipment at unitylabservices.com

Support Plans | Parts and Consumables | Training and More



pipette warranty registration

Register your pipette online for a free warranty at www.thermoscientific.com/pipetwarranty

© 2016 Thermo Fisher Scientific Inc. All rights reserved. Specifications, terms and pricing are subject to change. Not all products are available in all countries. “STERRAD” (Ethicon) is a trademark of their respective owners. All other trademarks owned by Thermo Fisher Scientific or its subsidiaries. Please consult your local sales representative for details.

North America: 800 625 4327

Europe: Austria +43 1 801 40 0, Belgium +32 53 73 42 41, France +33 2 2803 2180, Germany national toll free 08001-536 376, Germany international +49 6184 90 6000, Italy +39 02 02 95059 552, Netherlands +31 76 571 4440, Nordic/Baltic/CIS countries +358 10 329 2200, Russia +7 (495) 739 76 41, Spain/Portugal +34 93 223 09 18, Switzerland +41 44 454 12 12, UK/Ireland +44 870 609 9203 or 44 (0) 161 486 2110

Asia: China +86 21 6865 4588 or +86 10 8419 3588, India toll free 1800 22 8374, India +91 22 6716 2200, Japan +81 45 453 9220, Other Asian countries +852 2885 4613 **Countries not listed:** +49 6184 90 6940 or +33 2 2803 2180

www.thermoscientific.com/handleanything

Thermo
SCIENTIFIC

A Thermo Fisher Scientific Brand