



United Scientific

Laboratory Products 2023



www.unitedsci.com

P: +1 847 336-7556



Properties of United Glassware

Chemical Composition:

Our glassware is manufactured from low-expansion Type 1, Class A Borosilicate 3.3 glass that complies with ASTM E438 Standard Specification for Glasses in Laboratory Apparatus.

It is low alkali glass with a typical chemical composition of approximately 81% silica, 13% boric oxide, 4% sodium oxide, and 2% aluminum oxide. It is virtually free of magnesia-lime-zinc group, and contains only traces of heavy metals.

Thermal Properties:

Borosilicate glass has a low coefficient of thermal expansion. Therefore, the thermal stresses under a given temperature gradient are low, and the glass can withstand higher temperature gradients as well as sudden temperature changes / thermal shocks. However, even minute scratching of glass surface can reduce its thermal resistance.

The 'Strain Point' (about 500°C) is generally recommended as the maximum safe operating temperature for United glassware. The glass may acquire permanent stresses upon cooling if it is heated above 500°C. Our glassware is annealed in modern ovens under strictly controlled conditions to ensure minimal residual stress.



Beakers, Low Form, Borosilicate Glass

Our beakers are made from low-expansion borosilicate glass. Beakers feature heavy and uniform wall thickness, spouts designed for easy pouring, beaded tops, and white printed graduations. The 20ml and larger sizes also have a double graduated metric scale (except for 20000ml) and a marking area. Tolerance for beakers is approximately +/- 5%.

Item No.	Capacity (ml)	Grad. Range (ml)	Grad. Interval (ml)	Quantity per pack	Quantity per case
BG1000-5	5	NA	NA	12	48
BG1000-10	10	NA	NA	12	48
BG1000-20	20	5-15	10	12	48
BG1000-25	25	10-20	10	12	48
BG1000-30	30	5-25	10	12	48
BG1000-50	50	10-40	10	12	48
BG1000-100	100	20-80	10	12	48
BG1000-150	150	20-140	20	12	48
BG1000-250	250	25-200	25	12	48
BG1000-400	400	50-300	25	12	48
BG1000-500	500	100-400	50	6	36
BG1000-600	600	100-500	50	6	36
BG1000-800	800	100-750	50	6	24
BG1000-1000	1000	100-900	50	6	24
BG1000-1500	1500	200-1400	200	4	16
BG1000-2000	2000	200-1800	200	1	8
BG1000-3000	3000	250-2500	250	1	4
BG1000-4000	4000	500-3500	500	1	6
BG1000-5000	5000	1000-4000	500	1	4
BG1000-10000	10000	2000-8000	1000	1	1
BG1000-20000	20000	4000-16000	2000	1	1

Chemical Durability:

United glassware is highly resistant to water, neutral and acid solutions, concentrated acids and their mixtures, as well as to chloride, bromine, iodine, and organic matters. Even during extended period of reaction and at temperatures above 100°C, its chemical resistance exceeds that of most metals and other materials. Our glassware can withstand repeated dry and wet sterilization and offers good resistance against various chemicals, except for hydrofluoric acid, hot phosphoric acid and alkaline solutions.

Optical Properties:

United glassware has a clear and colorless appearance, and shows no noticeable absorption in the visible region of the spectrum.

Safety:

Treated with proper care, United glassware will offer long-term, reliable service in the laboratory. Please contact us for detailed recommendations regarding heating and cooling, mixing and stirring, vacuum and pressure, cleaning, and safety precautions that must be followed while using glassware.



Beakers, Berzelius, Tall Form, Borosilicate Glass

Tall form Berzelius beakers include a spout. Our beakers are made from low-expansion borosilicate glass. Beakers feature heavy and uniform wall thickness, spouts designed for easy pouring, and beaded tops. Also include white printed graduations and a marking area. Tolerance for beakers is approximately +/- 5%.

Tall Form Berzelius Beakers with Spout					
Item No.	Capacity (ml)	Grad. Range (ml)	Grad. Interval (ml)	Quantity per Pack	Quantity per Case
BG1060-100	100	20-80	10	12	48
BG1060-200	200	25-150	25	12	48
BG1060-250	250	25-200	25	12	48
BG1060-300	300	25-250	25	12	48
BG1060-400	400	50-300	25	6	36
BG1060-500	500	100-400	50	6	24
BG1060-600	600	100-500	50	6	24
BG1060-1000	1000	100-900	50	6	18

Tall Form Berzelius Beakers without Spout					
Item No.	Capacity (ml)	Grad. Range (ml)	Grad. Interval (ml)	Quantity per Pack	Quantity per Case
BG1040-100	100	20-80	10	12	48
BG1040-250	250	25-200	25	12	48
BG1040-500	500	100-400	50	6	24



Labware Beakers



Beakers, Low Form, Heavy Duty, Borosilicate Glass

Heavy duty beakers are ideal for tough handling conditions including mechanized washing. Beakers feature a white double graduated metric scale and a marking area. Tolerance is approximately $\pm 5\%$.

Item No.	Capacity (ml)	Grad. Range (ml)	Grad. Interval (ml)	Quantity per Pack	Quantity per Case
BG1003-100	100	20-80	10	12	48
BG1003-150	150	20-140	20	12	48
BG1003-250	250	25-200	25	12	48
BG1003-400	400	50-300	25	12	48
BG1003-600	600	100-500	50	6	36
BG1003-1000	1000	100-900	50	1	24
BG1003-2000	2000	200-1800	200	1	8
BG1003-4000	4000	500-3500	500	1	6



Glass Beaker Set of 5, Borosilicate Glass

An ideal starter set for any laboratory, this set contains five borosilicate glass beakers in sizes 50ml, 100ml, 250ml, 600ml, and 1000ml.

Item No.	Description
BGSET5	Glass Beaker Set of 5, Borosilicate



BGMG400



BGMG600-T

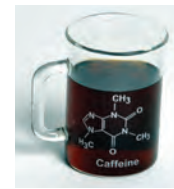

Back of beakers shows the molecular structure of caffeine.

Beaker Mugs, Borosilicate Glass

These borosilicate glass beakers feature an attached handle and a smooth rim. The molecular structure of caffeine is enameled in white on one side, and the other side has dual metric graduations. Available in Low Form 400ml and Tall Form 600ml versions.

Item No.	Description
BGMG400	Beaker Mug, Low Form, 400ml
BGMG600-T	Beaker Mug, Tall Form, 600ml

Beaker mugs can be private labeled. Please call for details.



Plastic Beaker Set of 5, PP

This handy set for any laboratory contains five graduated polypropylene beakers in sizes 50ml, 100ml, 250ml, 500ml and 1000ml.

Item No.	Description
BPSET5	Plastic Beaker Set of 5, PP



Plastic Beaker Set of 5, Polymethylpentene (PMP)

This set of polymethylpentene beakers offers glass-like clarity with the durability of plastic. Includes five graduated PMP beakers in sizes 50ml, 100ml, 250ml, 500ml and 1000ml.

Item No.	Description
BMSET5	Plastic Beaker Set of 5, PMP



Properties of United Plastic Labware

Our plastic labware is manufactured from high-quality resins. Treated with proper care, United plasticware will offer long-term satisfactory service in the laboratory. Please refer to the chart below for physical properties of United plasticware.

Physical Properties of United Plastic Labware

Resin	Maximum Use Temperature (°C)	Brittleness Temperature (°C)	Transparency	Autoclavable*
High Density Polyethylene (HDPE)	120	-100	Translucent	No
Low Density Polyethylene (LDPE)	80	-100	Translucent	No
Polycarbonate (PC)	135	-135	Clear	Yes
Acrylic (PMMA)	50	20	Clear	No
Polymethylpentene (PMP)	175	20	Clear	Yes
Polypropylene (PP)	135	0	Translucent	Yes
Polystyrene (PS)	90	20	Clear	No
Polytetrafluoroethylene (PTFE)	270	-200	Opaque	Yes
Polyvinyl Chloride (PVC)	70	-30	Clear	No

*Autoclave at 121°C, 15 psi for 20 minutes. Clean and rinse item with distilled water before autoclaving. Certain chemicals which have no appreciable effect on resins at room temperature may cause deterioration at autoclaving temperatures.

Chemical Properties of United Plastic Labware

Class of Substance at Room Temperature	HDPE	LDPE	PC	PMMA	PP	PS	PSF	PTFE	PMP
Acids, Dilute or Weak	E	E	E	G	E	E	E	E	E
Acids, Strong and Concentrated	E	E	N	N	E	F	G	E	E
Alcohols, Aliphatic	E	E	G	N	E	E	G	E	E
Aldehydes	G	G	F	G	G	N	F	E	G
Bases	E	E	N	F	E	E	E	E	E
Esters	G	G	N	N	G	N	N	E	G
Hydrocarbons, Aliphatic	G	F	F	G	G	N	G	E	F
Hydrocarbons, Aromatic	G	F	N	N	F	N	N	E	F
Hydrocarbons, Halogenated	F	N	N	N	F	N	N	E	N
Ketones	G	G	N	N	G	N	N	E	F
Oxidizing Agents, Strong	F	F	N	N	F	N	G	E	F

Resin Code	
HDPE	High-density polyethylene
LDPE	Low-density polyethylene
PC	Polycarbonate
PMMA	Polymethyl methacrylate
PP	Polypropylene
PS	Polystyrene
PSF	Polysulfone
PTFE	Polytetrafluoroethylene
PMP	Polymethylpentene

Chemical Resistance Classification

- E = Excellent - 30 days of constant exposure cause no damage. Plastics may even tolerate for years.
- G = Good - Little or no damage after 30 days of constant exposure to the reagent.
- F = Fair - Some effect after 7 days of constant exposure to the reagent like crazing, cracking, loss of strength or discoloration.
- N = Not Recommended - Not for continuous use. Immediate damage may occur.

Please contact us for detailed information regarding compatibility of our plasticware with specific chemicals.



Beakers, Griffin Style, Polypropylene (PP)

Beakers molded in polypropylene have excellent clarity and chemical resistance. They are autoclavable and feature raised graduations on the outer surface. Griffin Style beakers nest without sticking together.

Item No.	Capacity (ml)	Graduation Interval (ml)	O.D. x Height (mm)	Quantity per pack
BP0050	50	5	55 x 55	12
BP0100	100	5	60 x 62	12
BP0250	250	10	85 x 100	6
BP0500	500	10	100 x 120	4
BP0600	600	10	110 x 125	4
BP1000	1000	25	124 x 150	3
BP2000	2000	250	155 x 185	3

Beakers, New Style, PP

Beakers, molded in polypropylene, have excellent clarity and very good chemical resistance. They are autoclavable and feature raised graduations on the outer surface. New Style beakers feature oversized, tapered spouts for easier pouring of solutions.

Item No.	Capacity (ml)	Graduation Interval (ml)	O.D. x Height (mm)	Quantity per pack
11110	25	5	34 x 49	12
11111	50	5	43 x 54	12
11112	100	5	53 x 62	12
11113	250	10	72 x 100	6
11114	500	10	89 x 120	4
11115	1000	25	110 x 150	3
11116	2000	50	135 x 184	3
11117	5000	200	213 x 260	1



Stackable Beakers, PP

Polypropylene beakers are highly flexible - a gentle squeeze creates a spout anywhere on the rim. Raised molded ribs prevent the beakers from sticking together. Autoclavable.

Item No.	Capacity	Graduation Interval	O.D. x Height (mm)	Quantity per pack
BST120-PK/25	120ml/4 oz.	10ml/0.5 oz.	70 x 64	25
BST120-CASE	120ml/4 oz.	10ml/0.5 oz.	70 x 64	1000
BST500-PK/25	500ml/17 oz.	50ml/1 oz.	108 x 95	25
BST500-CASE	500ml/17 oz.	50ml/1 oz.	108 x 95	500



Tri-Corner Beakers, PP

These sturdy polypropylene beakers feature three pouring lips for drip-less dispensing. Beakers are graduated in both ounces and milliliters. Available in packs of 100, or as an assortment of 30 beakers featuring five of each size.

Item No.	Capacity	Graduation Interval	O.D. x Height (mm)	Quantity per pack
BTC0050	50ml/1.5 oz.	10ml/0.5 oz.	57 x 67	100
BTC0100	100ml/3.5 oz.	10ml/0.5 oz.	71 x 84	100
BTC0250	250ml/8 oz.	20ml/1 oz.	88 x 101	100
BTC0400	400ml/13 oz.	40ml/1 oz.	111 x 115	100
BTC0800	800ml/26 oz.	50ml/2 oz.	137 x 134	100
BTC1000	1000ml/32 oz.	50ml/2 oz.	143 x 141	100

Item No.	Description
BTCST30	Tri-Corner Beaker Set (five each of 50ml, 100ml, 250ml, 400ml, 800ml, and 1000ml sizes)



Beakers, Printed Graduations, PP

Polypropylene beakers with pouring spouts are ideal for general laboratory use. Tapered design is convenient for stacking and holding. All sizes have easy to read silk-screened graduations. Autoclavable.

Item No.	Capacity (ml)	Height (mm)	Quantity per pack
P50601	50	59	12
P50602	100	73	12
P50603	250	94	12
P50604	500	128	6
P50605	1000	150	4
P50606	2000	190	4
P50607	5000	263	2
P50608	10000	330	1



Beakers, Printed Graduations, PMP

Polymethylpentene beakers with pouring spouts are ideal for general laboratory use. Tapered design is convenient for stacking and holding. All sizes have easy to read silk-screened graduations. Autoclavable.

Item No.	Capacity (ml)	Height (mm)	Quantity per pack
P50701	50	59	12
P50702	100	73	12
P50703	250	94	12
P50704	500	128	6
P50705	1000	150	4
P50706	2000	190	4
P50707	5000	263	2
P50708	10000	330	1



Beakers with Handle, Printed Graduations, PP

Polypropylene beakers with pouring spouts are ideal for general laboratory use. Includes rectangular handle for easy carrying and pouring. All sizes have easy to read silk-screened graduations. Autoclavable.

Item No.	Capacity (ml)	Height (mm)	Quantity per pack
P50802	100	73	6
P50803	250	94	6
P50804	500	128	6
P50805	1000	150	4
P50806	2000	190	4
P50807	5000	248	2
P50808	10000	330	1



Beakers with Handle, Printed Graduations, PMP

Polymethylpentene beakers with pouring spouts are ideal for general laboratory use. Includes rectangular handle for easy carrying and pouring. All sizes have easy to read silk-screened graduations. Autoclavable.

Item No.	Capacity (ml)	Height (mm)	Quantity per pack
P50902	100	73	6
P50903	250	94	6
P50904	500	128	6
P50905	1000	150	4
P50906	2000	190	4
P50907	5000	248	2
P50908	10000	330	1



NEW PRODUCT

Hand Protector, Silicon Rubber

Made of silicone rubber and features special grips to prevent containers from slipping. Ideal for gripping hot objects such as beakers, flasks and bottles.

Item No.	Description
HNDPTC	Hand Protector, Silicon Rubber



Beaker Brushes, Nylon Bristles

Good quality nylon black bristles mounted on a wooden handle. Includes a radial top.

Item No.	Brush Length	Brush Diameter	Overall Length	Quantity per pack
BBR013	6"	3"	13"	1
BBR016	6"	3"	16"	1



Beaker Tongs

Beaker tongs open to 7" and feature strong zinc-plated steel construction with flat riveted joints and vinyl coated sleeves. Tongs can handle beakers from 50ml to 1500ml capacity. Overall length is 9.75".

Item No.	Description
BTSP09	Beaker Tongs



Beakers with Handle, Tall Form, PP

Tall form beakers with raised graduations, molded in polypropylene, are clear, autoclavable and have good chemical resistance. All sizes have handles for convenient lifting.

Item No.	Capacity (ml)	Top Flange Diameter (mm)	Height (mm)	Graduation Interval (ml)	Quantity per pack
81101	250	83	99	10	12
81102	500	97	126	10	12
81103	1000	114	170	10	6
81104	2000	150	212	20	6



Beakers with Handle, Short Form, PP

Short form beakers with raised graduations, molded in polypropylene, are clear, autoclavable and have good chemical resistance. All sizes have handles for convenient lifting.

Item No.	Capacity (ml)	Top Flange Diameter (mm)	Height (mm)	Graduation Interval (ml)	Quantity per pack
81121	500	95	110	25	12
81122	1000	122	132	50	6
81123	2000	145	167	50	6
81124	3000	170	188	100	6
81105	5000	184	225	250	1

Item No.	Description
PJSET5	Set of 5 Beakers with Handle (one each of 500ml, 1000ml, 2000ml, 3000ml, and 5000ml sizes)



Reagent Bottles, Narrow Mouth, PP

These autoclavable narrow mouth polypropylene bottles are rigid, translucent and have excellent contact clarity. Include polypropylene caps.

Item No.	Capacity (ml/oz)	Height (mm)	Neck I.D. (mm)	Cap Size (mm)	Qty per pack	Qty per case
33253	15 / 0.5	58	14	20	12	1000
33254	30 / 1	62	14	20	12	1000
33301	60 / 2	85	14	20	12	500
33302	125 / 4	101	18	24	12	500
33303	250 / 8	133	18	24	12	250
33304	500 / 16	170	21	28	12	125
33305	1000 / 32	216	21	28	6	50



Reagent Bottles, Wide Mouth, PP

These autoclavable wide mouth polypropylene bottles are rigid, translucent and have excellent contact clarity. Include polypropylene caps.

Item No.	Capacity (ml/oz)	Height (mm)	Neck I.D. (mm)	Cap Size (mm)	Qty per pack	Qty per case
33311	30 / 1	63	21	28	12	1000
33306	60 / 2	86	21	28	12	500
33307	125 / 4	100	28	38	12	500
33308	250 / 8	131	33	43	12	250
33309	500 / 16	170	43	53	12	125
33310	1000 / 32	200	53	63	6	50



Scan to view demonstration video



Reagent Bottles, Narrow Mouth, HDPE

These high density polyethylene narrow mouth bottles are translucent, pliable and have excellent strength. Include polypropylene caps.

Item No.	Capacity (ml/oz)	Height (mm)	Neck I.D. (mm)	Cap Size (mm)	Qty per pack	Qty per case
33401	60 / 2	85	14	20	12	500
33402	125 / 4	101	18	24	12	500
33403	250 / 8	133	18	24	12	250
33404	500 / 16	170	21	28	12	125
33405	1000 / 32	216	21	28	6	50



Reagent Bottles, Wide Mouth, HDPE

These high density polyethylene wide mouth bottles are translucent, pliable and have excellent strength. Include polypropylene caps.

Item No.	Capacity (ml/oz)	Height (mm)	Neck I.D. (mm)	Cap Size (mm)	Qty per pack	Qty per case
33406	60 / 2	86	21	28	12	500
33407	125 / 4	100	28	38	12	500
33408	250 / 8	131	33	43	12	250
33409	500 / 16	176	43	53	12	125
33410	1000 / 32	200	53	63	6	50



Labware Bottles



NEW PRODUCT

90ml bottle includes a lined PP cap.

Reagent Bottle, Narrow Mouth, HDPE, 90ml

This unique narrow mouth bottle has a capacity of 90ml and a lined polypropylene cap. Constructed of high density polyethylene, the bottle is translucent, pliable, and has excellent strength. Sold as a pack of 500.

Item No.	Description
BNM090	Reagent Bottle, Narrow Mouth, HDPE, 90ml, case of 500



Wash Bottles, Unitary, Colored Caps, LDPE

Set of four 500ml LDPE bottles are translucent and manufactured from low density polyethylene (LDPE). Graduated on the outer surface to reflect an approximate volume of solution filled or dispensed. Bottles include polypropylene (PP) caps, one each of red, yellow, blue and white.

Item No.	Description
WBSET4	Wash Bottles, Unitary, Colored Caps, LDPE, 500ml, set of 4

Wash Bottles, LDPE



These bottles are made of translucent and low density polyethylene. Solutions can be dispensed easily by lightly squeezing the bottle. The flexible polyethylene delivery tube can be directed wherever required.

Item No.	Capacity (ml)	Quantity per pack
36601	125	12
36602	250	12
36603	500	6
36604	1000	6



Wash Bottles, Unitary, Red, LDPE



The red color of these 500ml wash bottles provides a visual indicator that they may contain hazardous liquids. Constructed of low density polyethylene, these bottles include a built-in delivery tube.

Item No.	Description	Quantity per pack
36606-R	Wash Bottle, Unitary, Red, LDPE, 500ml	4

Wash Bottles, Unitary, LDPE

These bottles are made of translucent and low density polyethylene. The distinguishing feature of these bottles is the built-in delivery tube which makes it a one-piece wash bottle. Include raised graduations on the outer surface to reflect an approximate volume of solution filled or dispensed.

Item No.	Capacity (ml)	Graduation Interval (ml)	Quantity per pack
36607	125	25	12
36605	250	50	12
36606	500	100	12



Labware Bottles



Carboys, PP

These polypropylene, autoclavable carboys feature wide handles for convenient carrying and pouring. Ideal for storing various laboratory solutions. Threads should be completely disengaged before autoclaving.

Item No.	Capacity (L)	O.D. x Height (mm)	Mouth I.D. (mm)	Quantity per pack
34001	10	250 x 430	67	1
34002	20	300 x 542	67	1



Carboys with Stopcock, PP

These polypropylene, autoclavable carboys are equipped with a preassembled leak-proof stopcock. Ideal for storing and dispensing various laboratory solutions. Threads should be completely disengaged before autoclaving.

Item No.	Capacity (L)	O.D. x Height (mm)	Mouth I.D. (mm)	Quantity per pack
34051	10	250 x 430	67	1
34052	20	300 x 542	67	1



Bottle, Vacuum, PP

This heavy-duty autoclavable bottle features thick walls and is designed for repeat vacuum applications. Cap includes a non-toxic silicone O-ring for a secure seal. Threads should be completely disengaged before autoclaving.

Item No.	Capacity (ml)	O.D. x Height (mm)	Mouth I.D. (mm)	Quantity per pack
33521	2000	120 x 275	40	1



Aspirator Bottles, PP

These lightweight, autoclavable aspirator bottles are made from polypropylene and can be used for dispensing distilled water and other laboratory solutions. The leak-proof spigot screwed to the bottle requires only a half turn to open or close. Polyethylene cap and stopcock should be removed before autoclaving.

Item No.	Capacity (L)	O.D. x Height (mm)	Mouth I.D. (mm)	Quantity per pack
34101	5	165 x 350	45	1
34102	10	190 x 450	45	1
34103	20	230 x 520	45	1



Bottle, Square, Wide Mouth, PP

This large, autoclavable polypropylene bottle can be used for storing and shipping chemicals and reagents. The 86mm diameter opening makes it easy to fill and dispense contents. Bottle features built-in grips on two sides for secure handling. Threads should be completely disengaged before autoclaving.

Item No.	Capacity (ml)	O.D. x Height (mm)	Mouth I.D. (mm)	Quantity per pack
33511	4000	137 x 290	86	1



Bottles, Storage, Wide Mouth, PP

These polypropylene bottles provide an excellent option for storage of reagents and other materials in the laboratory. The square shape is designed to optimize shelf space. Available in three different sizes, these bottles feature polypropylene caps, are autoclavable, and provide good chemical resistance.

Item No.	Capacity (ml)	O.D. x Height (mm)	Mouth I.D. (mm)	Quantity per pack
81900	250	64 x 87	36	12
81901	500	78 x 115	49	12
81902	1000	100 x 135	71	6



Barnes Dropping Bottle, 30ml, Glass

Square-shaped, clear flint glass bottles with glass pipet and rubber bulb stopper. Capacity 30ml. Replacement pipets also available. Standard pack quantity is 36 each.



Item No.	Description
BOT030	Barnes Dropping Bottle, with pipet and rubber bulb
BOT030-PK/36	Barnes Dropping Bottle, with pipet and rubber bulb, pack of 36
BPB010-PK/12	Replacement pipets and bulbs, pack of 12
BULB010-PK/12	Replacement bulbs, pack of 12



BPB002



BPB004

NEW PRODUCT

Eye Droppers, Glass

Straight glass pipettes with tapered rubber bulbs. Available in two sizes: approximately 70mm long with 2ml capacity, and approximately 100mm long with 4ml capacity.

Item No.	Description
BPB002-PK/3	Eye Dropper, 2ml, pack of 3
BPB002-PK/12	Eye Dropper, 2ml, pack of 12
BPB002-PK/72	Eye Dropper, 2ml, pack of 72
BPB004-PK/12	Eye Dropper, 4ml, pack of 12

NEW PRODUCT

Dropper Bottle, Assembled, LDPE, 30ml

This dropper bottle is made of translucent and low density polyethylene. Bottle can be used with or without dropper.



Item No.	Description
PDB030	Dropper Bottle, Assembled, LDPE, 30ml

NEW PRODUCT

Dropper, Plastic

Straight plastic pipettes with rubber bulbs.



Item No.	Description
PLPIP3	Dropper, Plastic, 3", Pack of 12



BOD Bottles, Numbered, Borosilicate Glass

BOD Bottles for incubating diluted samples of clean, waste, effluent, and polluted water during the 5-day biochemical oxygen demand (BOD) test. Bottles are numbered to allow for convenient organization of samples. 300ml bottles also include a bar code. Glass robotic stoppers are included.

Available in series of numbers from 1 through 432 in increments of 36 (60ml size) or 24 (300ml size). Please specify series of numbers when placing your order.

Item No.	Description	Quantity per pack
BOD060-N	BOD Bottle, 60ml, numbered	36
BOD300-N	BOD Bottle, 300ml, numbered and barcoded	24
BODCAR	BOD Bottle Carrier	1



BOD060



BOD300



BODCAR

BOD Bottles, Borosilicate Glass

BOD Bottles for incubating diluted samples of clean, waste, effluent, and polluted water during the 5-day biochemical oxygen demand (BOD) test. Bottles are unnumbered and feature a penny head stopper.

Item No.	Description	Quantity per pack
BOD060	BOD Bottle, 60ml, unnumbered	36
BOD300	BOD Bottle, 300ml, unnumbered	24
BODCAR	BOD Bottle Carrier	1

Bottle, 60ml, Glass

Round, clear flint glass bottle, 60ml capacity. Size 0 stopper can be used for closure.



Item No.	Description
BOT060	Bottle, 60ml, Glass



Media / Storage Bottles, Clear, Borosilicate Glass

These borosilicate glass general purpose media bottles are autoclavable with permanent white imprinted graduations and marking spots. The screw thread opening has an I.D. of approximately 30mm. The supplied GL 45 cap is liner-less and both the cap and drip-free ring are polypropylene and autoclavable to 140°C. Maximum use temperature of bottles is 450°C.

Item No.	Capacity (ml)	Graduation Range (ml)	O.D. x Height (mm)	Quantity per pack
BM0100	100	20-80	56 x 100	10
BM0250	250	50-200	70 x 138	10
BM0500	500	100-400	86 x 175	10
BM1000	1000	100-900	101 x 225	10
BM2000	2000	400-1800	136 x 262	4



NEW PRODUCT

Media / Storage Bottles, Amber, Borosilicate Glass

Designed for storing and transporting light sensitive materials, amber media / solutions bottles are autoclavable with permanent white imprinted graduations and marking spots. The supplied GL 45 cap is liner-less and both the cap and drip-free ring are polypropylene and autoclavable to 140°C. Maximum use temperature of bottles is 450°C.

Item No.	Capacity (ml)	Graduation Range (ml)	OD x Height (mm)	Qty. per Pack
BMA0100	100	40 - 80	56 x 105	10
BMA0250	250	50 - 200	70 x 143	10
BMA0500	500	100 - 400	86 x 182	10
BMA1000	1000	100 - 900	101 x 203	10

Additional sizes including 2L, 5L, 10L, and 20L capacity bottles are available. Contact us for details.



NEW PRODUCT

Media / Storage Bottles, Square, Clear Polycarbonate (PC)

Clear, square disposable polycarbonate bottles are space-saving and convenient to handle. Useful for mixing, sampling, and storage applications. Graduations and large marking spot are screened in easy-to-read white enamel. Includes a blue, liner-less GL 45 polypropylene plug-seal autoclavable cap. Neck ID is 37mm.

Polycarbonate bottles can be used in environments ranging from -80° to 130° Celsius. Sterilized using gamma radiation. Individually bagged. Bottles can be autoclaved once - repeated autoclaving is not recommended.

Item No.	Capacity (ml)	Graduation Range (ml)	Graduation Interval (ml)	Qty per pack
BMPC150	150	50 - 150	25	24
BMPC250	250	50 - 250	25	24
BMPC500	500	100 - 500	50	24
BMPC1000	1000	100 - 1000	50	24



NEW PRODUCT

Media / Storage Bottles, Square, Clear Plastic (PET)

Clear, square disposable polyethylene terephthalate (PET) bottles are space-saving and convenient to handle. Useful for mixing, sampling, and storage applications. Includes a blue, liner-less GL 45 polypropylene plug-seal autoclavable cap and features raised graduations. Neck ID is 37mm.

PET is transparent, lightweight, and break-resistant. Bottles can be used in environments ranging from -40° to 50° Celsius. Sterilized using gamma radiation. Individually bagged. PET cannot be autoclaved.

Item No.	Capacity (ml)	Graduation Range (ml)	Graduation Interval (ml)	Qty. per pack
BMPE250	250	50 - 250	25	12
BMPE500	500	100 - 500	50	12
BMPE1000	1000	100 - 1000	50	12



NEW PRODUCT

Bottles with Dropper, Boston Round, Amber, Flint Glass

These amber boston round flint glass bottles include screw cap with dropper assembly are designed for general use. The glass is non-porous, which allows for easy cleaning or autoclaving. The amber color helps protect light sensitive materials.

Item No.	Description	Qty per pack
BDPSC-AM-0.5OZ	Bottles with Dropper, Boston Round, Amber, 0.5oz	12
BDPSC-AM-1OZ	Bottles with Dropper, Boston Round, Amber, 1oz	12
BDPSC-AM-2OZ	Bottles with Dropper, Boston Round, Amber, 2oz	12
BDPSC-AM-4OZ	Bottles with Dropper, Boston Round, Amber, 4oz	12
BDPSC-AM-8OZ	Bottles with Dropper, Boston Round, Amber, 8oz	12



NEW PRODUCT

Bottles with Dropper, Square, Flint Glass

These square flint glass bottles include screw cap with dropper assembly are designed for general use. The glass is non-porous, which allows for easy cleaning or autoclaving.

Item No.	Description	Qty per pack
BDFSQ-0.5OZ	Bottles with Dropper, Square, Flint Glass, 0.5oz	12
BDFSQ-1OZ	Bottles with Dropper, Square, Flint Glass, 1oz	12



NEW PRODUCT

Flint Bottles, Boston Round, Clear

These Boston Round Flint Bottles include screw cap with dropper assembly are designed for general use. The glass is non-porous, which allows for easy cleaning or autoclaving.

Item No.	Description	Qty per pack
BDPSC-0.5OZ	Flint Bottles, Boston Round, 0.5oz	12
BDPSC-1OZ	Flint Bottles, Boston Round, 1oz	12
BDPSC-2OZ	Flint Bottles, Boston Round, 2oz	12
BDPSC-4OZ	Flint Bottles, Boston Round, 4oz	12
BDPSC-8OZ	Flint Bottles, Boston Round, 8oz	12



NEW PRODUCT

Media / Storage Bottles, Square, Wide Mouth (GL 80), Borosilicate Glass

Our wide mouth, square-shaped, media bottles have large openings that enable the easy storage and transfer of substances. Every bottle is autoclavable and comes with easy to read imprinted graduations. GL80 Polypropylene screw caps are included.

Item No.	Capacity (ml)	Grad. Range (ml)	Grad. Interval (ml)	O.D. x Height (mm)	Quantity per pack
BSWM500	500	100-500	100	94 x 139	10
BSWM1000	1000	200-1000	100	105 x 185	10
BSWM2000	2000	400-2000	200	115 x 258	6
BSWM5000	5000	1000-5000	500	160 x 357	1



NEW PRODUCT

Media / Storage Bottles, Square (GL 45), Borosilicate Glass

Space-saving, square-shaped borosilicate glass general purpose media bottles are autoclavable with permanent white imprinted graduations and marking spots. The screw thread opening has an I.D. of approximately 30mm. The supplied GL 45 cap is liner-less and both the cap and drip-free ring are polypropylene and autoclavable to 140°C. Maximum use temperature of bottles is 450°C.

Item No.	Capacity (ml)	Graduation Range (ml)	O.D. x Height (mm)	Quantity per pack
BMS0250	250	50-200	64 x 143	10
BMS0500	500	100-400	78 x 181	10
BMS1000	1000	100-900	94 x 222	10



Volumetric Ware background information

United volumetric glassware is of high quality and manufactured to ASTM standards using state-of-the-art manufacturing and calibration equipment. The calibration laboratory is NABL accredited in accordance with ISO 17025:2005 standards.

Class A versions of our volumetric ware comply with USP (United States Pharmacopia) standards. Burettes and pipettes are calibrated 'to deliver' (TD, Ex). Flasks and graduated cylinders are calibrated 'to contain' (TC, In).

Class B volumetric instruments feature tolerances that are about twice that of comparable Class A instruments (e.g. if a Class A burette has a tolerance of $\pm 0.05\text{ml}$, the corresponding Class B version will have a tolerance of approximately $\pm 0.10\text{ml}$).

Volumetric instruments can be heated up to 250°C in a drying cabinet or sterilizer without any resulting volume changes. Never heat volumetric instruments on a hot plate.

The standard reference temperature (i.e., the temperature at which volumetric instruments will contain or dispense their stated volume) is 20°C .



United's volumetric ware is calibrated in a NABL-accredited laboratory.

Burettes, Class A, with Straight Bore PTFE Key Stopcock, Batch Certified

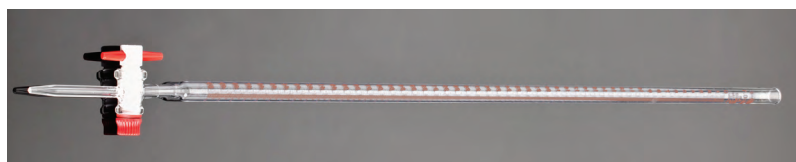

Class A, ASTM E287, meets USP standards, batch certified. Waiting time of 30 seconds. Manufactured from precision bore tubing and calibrated To Deliver (TD, Ex) on computer-controlled machines. Includes PTFE straight bore stopcock.

Item No.	Capacity (ml)	Graduation Interval (ml)	Tolerance (\pm ml)	Quantity per pack
BR2129-10	10	0.05	0.02	1
BR2129-25	25	0.10	0.03	1
BR2129-50	50	0.10	0.05	1

www.glasscolabs.com		GLASSCO	
BURETTE WITH PTFE STOPCOCK			
CLASS A			
CATALOGUE NO	:	115 450 01	ISO 9001:2008
NOMINAL VOLUME	:	10.00 ml	
TOLERANCE	:	± 0.020 ml	
COMPLIANCE	:	ASTM E-287	
BATCH NO	:	11-13	
MEAN VOLUME DEL.	:	9.990 ml	
STANDARD DEVIATION	:	0.004 ml	
TESTING DEVICE NAME	:	SARTORIUS	
BALANCE	:	ABAL-12,420g/0.001g	
WEIGHTS	:	10g	
THERMOMETER	:	DM-03,-50 to200	
	:	DEG C/0.1DEG	
OPERATOR	:	ROSHNI	
DATE OF ISSUE	:	11-11-13	

Each burette includes a batch calibration certificate.



Burettes, Class A, with Straight Bore PTFE Key Stopcock, Individually Certified

Class A, ASTM E287, meets USP standards, serialized and certified. Waiting time of 30 seconds. Manufactured from precision bore tubing and calibrated To Deliver (TD, Ex) on computer-controlled machines. Includes PTFE straight bore stopcock.

Item No.	Capacity (ml)	Graduation Interval (ml)	Tolerance (\pm ml)	Quantity per pack
BR2128-10	10	0.05	0.02	1
BR2128-25	25	0.10	0.03	1
BR2128-50	50	0.10	0.05	1

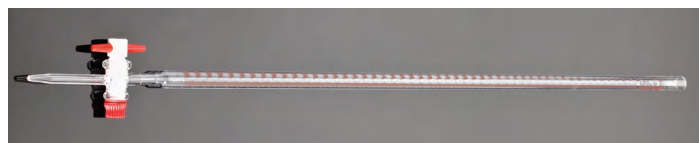

Each burette includes an individually serialized certificate.

Burettes, Class A, with Screw Thread Stopcock, Batch Certified



www.glasscolabs.com		GLASSCO	
BURETTE WITH PTFE STOPCOCK			
CLASS A			
CATALOGUE NO	115 450 01	ISO 9001:2008	
NOMINAL VOLUME	10.00 ml		
TOLERANCE	± 0.020 ml		
COMPLIANCE	ASTM E-287		
BATCH NO	11.13		
MEAN VOLUME DEL.	9.990 ml		
STANDARD DEVIATION	0.004 ml		
TESTING DEVICE NAME	SARTORIUS		
BALANCE	ABAL-12,420g/0.001g		
WEIGHTS	10g		
THERMOMETER	DM-03,-50 to200		
OPERATOR	DEG C/0.1DEG		
DATE OF ISSUE	ROSHNI		
	11.11.13		

Each burette includes a batch calibration certificate.

Class A, ASTM E287, meets USP standards, batch certified. Waiting time of 30 seconds. Manufactured from precision bore tubing and calibrated To Deliver (TD, Ex) on computer-controlled machines. Includes PTFE screw thread stopcock.

Item No.	Capacity (ml)	Graduation Interval (ml)	Tolerance (\pm ml)	Quantity per pack
BR2121-10	10	0.05	0.02	1
BR2121-25	25	0.10	0.03	1
BR2121-50	50	0.10	0.05	1

Burettes, Class A, with Screw Thread Stopcock, Individually Certified

Class A, ASTM E287, meets USP standards, serialized and certified. Waiting time of 30 seconds. Manufactured from precision bore tubing and calibrated To Deliver (TD, Ex) on computer-controlled machines. Includes PTFE screw thread stopcock.

Item No.	Capacity (ml)	Graduation Interval (ml)	Tolerance (\pm ml)	Quantity per pack
BR2120-10	10	0.05	0.02	1
BR2120-25	25	0.10	0.03	1
BR2120-50	50	0.10	0.05	1



Each burette includes an individually serialized certificate.



Burettes, Class B, with Straight Bore PTFE Key Stopcock

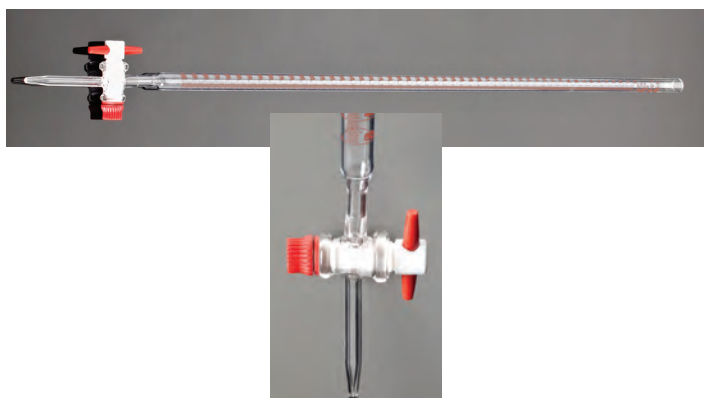

Burettes are made from the highest quality accurate bore tubing to provide a high degree of accuracy, reliability, and durability. All graduations are in resilient white enamel. Includes PTFE straight bore stopcock. Accuracy as per Class B.

Item No.	Capacity (ml)	Graduation Interval (ml)	Tolerance (\pm ml)	Quantity per pack
BR2130-10	10	0.05	0.04	1
BR2130-25	25	0.10	0.06	1
BR2130-50	50	0.10	0.10	1
BR2130-100	100	0.20	0.20	1

Burettes, Class B, with Screw Thread Stopcock



Include general purpose screw thread stopcocks with PTFE keys. Burettes are made from the highest quality accurate bore tubing to provide a high degree of accuracy, reliability, and durability. All graduations are in resilient white enamel. Includes PTFE screw thread stopcock. Accuracy as per Class B.

Item No.	Capacity (ml)	Graduation Interval (ml)	Tolerance (\pm ml)	Quantity per pack
BR2122-10	10	0.05	0.04	1
BR2122-25	25	0.10	0.06	1
BR2122-50	50	0.10	0.10	1
BR2122-100	100	0.20	0.20	1

Stopcock plugs are not interchangeable. We recommend using different types of greases depending on the reagent used. Please call for details.

Burettes, Class B, with Straight Bore Glass Stopcock

Burettes are made from the highest quality accurate bore tubing to provide a high degree of accuracy, reliability, and durability. All graduations are in resilient white enamel. Includes a straight bore glass stopcock. Accuracy as per Class B.

Item No.	Capacity (ml)	Graduation Interval (ml)	Tolerance (\pm ml)	Quantity per pack
BR2124-10	10	0.05	0.04	1
BR2124-25	25	0.10	0.06	1
BR2124-50	50	0.10	0.10	1
BR2124-100	100	0.20	0.20	1



Burettes, Class B, with PTFE Detachable Stopcocks

Burettes are made from the highest quality accurate bore tubing to provide a high degree of accuracy, reliability, and durability. Accuracy as per Class B.

PTFE stopcock and tip detaches from the body of the burette for easy cleaning and convenient replacement of broken tips.

Item No.	Capacity (ml)	Graduation Interval (ml)	Tolerance (\pm ml)	Quantity per pack
BR2116-10	10	0.05	0.04	1
BR2116-25	25	0.10	0.06	1
BR2116-50	50	0.10	0.10	1

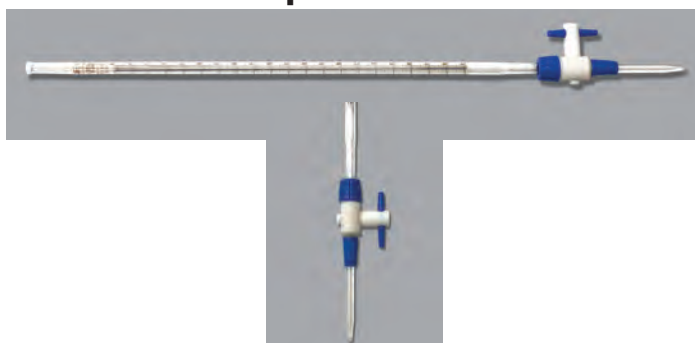

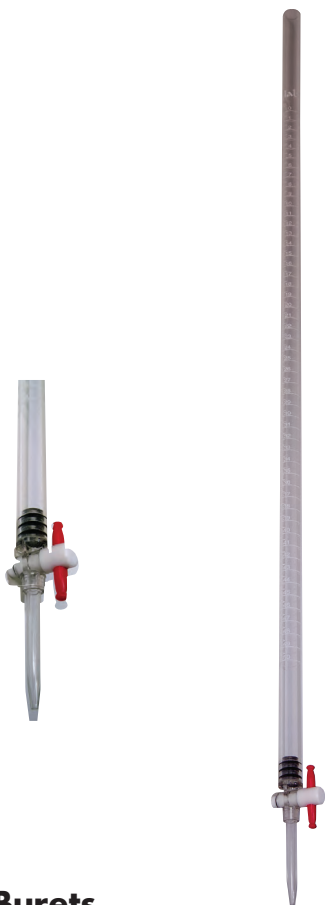

Acrylic Burets

This buret has a clear acrylic body and leak-proof stopcock with a self-lubricating PTFE plug. Acrylic body is resistant to dilute mineral acids and bases except Hydrofluoric Acid and Ammonium Hydroxide. Graduations are in 0.1ml increments.

Item No.	Capacity (ml)	Overall Length (mm)	Tolerance (\pm ml)	Quantity per pack
11501	25	570	0.25	1
11502	50	735	0.50	1
11503	100	835	1.20	1



BRA217-50 Automatic Burette shown with BRB2000 Bottle.

Automatic Burettes, Borosilicate Glass, Class A, Individually Certified

Self-zeroing burette mounts on a glass bottle. Includes a PTFE needle valve stopcock, intermediate stopcock and rubber bellows.

Class A, ASTM E-287, meets USP standards, individually serialized and certified. Includes Schellbach backing for easy reading of liquid levels. With amber graduations. Manufactured from precision bore tubing and calibrated To Deliver (TD, Ex) on computer-controlled machines.

Glass bottles with ground glass joints are sold separately. 500ml bottle size is compatible with the 10ml automatic burette. 2000ml bottle size is compatible with the 25ml and 50ml automatic burettes.

Item No.	Capacity (ml)	Graduation Interval (ml)	Tolerance (\pm ml)	Bottle Capacity (ml)	Qty per pack
BRA217-10	10	0.05	0.02	500	1
BRA217-25	25	0.10	0.03	2000	1
BRA217-50	50	0.10	0.05	2000	1

Item No.	Description	Qty per pack
BRB0500	Bottle only for Automatic Burettes, 500ml	1
BRB2000	Bottle only for Automatic Burettes, 2000ml	1



Burette Brush, Nylon Bristles

Good quality nylon bristles mounted in twisted heavy gauge galvanized wire. Includes a radial top.

Item No.	Brush Length	Brush Diameter	Overall Length	Quantity per pack
BUBR01	10"	1/2"	28"	1



Image shows close-up of Burette Brush bristles.



Microcentrifuge Tubes, PP

Made from high-quality virgin polypropylene, these microcentrifuge tubes are RNase, DNase and Pyrogen free for safer use in molecular biology and other biochemical applications. Include a connected snap cap, large molded-in graduations, and a frosted surface for easier writing. Autoclavable tubes can be used in very low temperatures and with various organic solvents. Maximum RCF 20000. Amber colored tubes are suitable for light sensitive applications because they do not allow any light to pass through the samples.

Item No.	Capacity (ml)	Outside Diameter (mm)	Height (mm)	Quantity per pack
P10201	0.5 (Natural)	10	31.5	1000
P10201A	0.5 (Amber)	10	31.5	1000
P10207	0.5 (Blue)	10	31.5	1000
P10202	1.5 (Natural)	13	41	500
P10204A	1.5 (Amber)	13	41	500
P10204	1.5 (Blue)	13	41	500
P10203	2.0 (Natural)	13	41	500
P10203A	2.0 (Amber)	13	41	500
P10205	2.0 (Blue)	13	41	500



Microcentrifuge Tubes, Rainbow Pack, PP

This convenient assortment includes 125 each of red, blue, yellow and green tubes. Please refer to our 'Microcentrifuge Tubes, PP' presentation for a detailed listing of tube specifications.

Item No.	Capacity (ml)	Outside Diameter (mm)	Height (mm)	Quantity per pack
P10204R	1.5	13	41	500

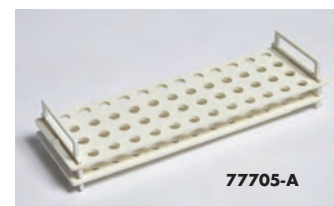
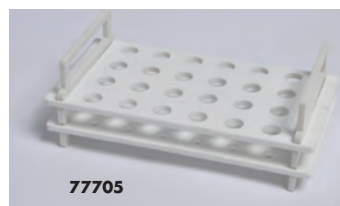

Racks for Microcentrifuge Tubes, PC

Polycarbonate racks hold 1.5ml microcentrifuge tubes. Unique design allows racks to be securely stacked on top of each other. Includes alpha-numeric grid for easy identification of tubes. Autoclavable.

Item No.	Description	Quantity per pack
77705	24 Places	4
77705-A	48 Places	4



Racks for Microcentrifuge Tubes, Interlocking, PP

Sturdy autoclavable racks are compatible with both 1.5ml and 2.0ml microcentrifuge tubes. Racks lock together on each side so that several can be attached for larger experiments. Holes have molded-in numbers for sample identification. Rubber supports on the bottom provide stability.

Item No.	Tube Capacity (ml)	Places	L x W x H (mm)	Quantity per pack
P20205	1.5 and 2.0	20 (10 x 2 array)	210 x 70 x 35	8



Floating Microtube Racks, PP

Floating microtube racks are ideal for thawing, cooling, or incubating samples in water or ice baths, at a wide range of temperatures from -70° to 100°C. Tubes are supported below the lip while conical ends are immersed in water. Racks feature a handle for easy removal from water bath, as well as a molded-in alpha-numeric grid for identification of samples.

Item No.	Description	Quantity per pack
63201	Floating Microtube Racks, PP	12



Racks for Microcentrifuge Tubes, PC

Stackable polycarbonate racks are compatible with both 1.5ml and 2.0ml microcentrifuge tubes. Holes have molded-in numbers and letters for sample identification. Ergonomic design provides easy insertion and removal of tubes. Can be used in wide temperature range (-135° to 135°C). Autoclavable.

Item No.	Tube Capacity (ml)	Places	Color	L x W x H (mm)	Qty per pack
P20201	1.5 and 2.0	24 (6 x 4 array)	White	164 x 100 x 59	8
P20202	1.5 and 2.0	24 (6 x 4 array)	Yellow	164 x 100 x 59	8
P20203	1.5 and 2.0	48 (12 x 4 array)	White	293 x 100 x 59	8
P20204	1.5 and 2.0	48 (12 x 4 array)	Yellow	293 x 100 x 59	8



Racks for Microcentrifuge Tubes, 100-Place, PP

Two-tier polypropylene racks hold up to 100 of 1.5ml microcentrifuge tubes. Racks are autoclavable and can be used in water baths or freezers. A molded-in alpha-numeric index makes sample identification easy. Racks are stackable and have a 2 3/4" x 1" labeling area on two sides.

Item No.	Description	Quantity per pack
77910	Rack for Microcentrifuge Tubes, PP	6

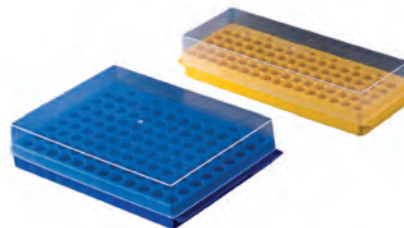

Reversible Racks for Microcentrifuge Tubes, PP

Polypropylene racks contain grids on both sides. One side holds 1.5/2.0ml microcentrifuge tubes with extra smaller positions for 0.5ml tubes, and the other side holds 0.5ml microcentrifuge tubes with extra positions for 1.5/2.0ml microcentrifuge tubes. The 96 place rack contains 12 x 8 arrays. The 80 place rack contains 16 x 5 arrays. Molded-in coding for easy identification of tubes. Autoclavable.

Item No.	Tube Capacity (ml)	Places	L x W x H (mm)	Quantity per pack
P20206	1.5, 2.0 & 0.5	96 (12 x 8 array)	220 x 150 x 50	6
P20207	1.5, 2.0 & 0.5	80 (16 x 5 array)	240 x 85 x 50	6



Reversible Racks for Microcentrifuge Tubes, Assorted Colors, PP

Reversible racks can be used for 0.5ml or 1.5ml capacity tubes. Both sides of the rack can hold up to 108 tubes, and feature alpha-numeric grid for inventory management. Included transparent lid can be used to cover either side to provide a clear view while protecting stored tubes. Autoclavable. Pack includes one each of red, orange, yellow, green and blue racks.

Item No.	Tube Capacity (ml)	Places	L x W x H (mm)	Quantity per pack
63211	0.5 or 1.5	108 (12 x 9 array)	210 x 133 x 52	5



16:1 crank to head gear ratio yields a head speed of 1152 RPM in 10 seconds.



Scan to view demonstration video

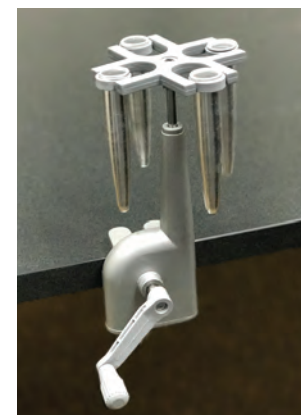

Hand Centrifuge

This hand-driven centrifuge comes with a table-mounting clamp. Features a painted metal body and metal head. Comes complete with four aluminum shields. Easily disassembles for storage in specially designed foam box. Crank is geared to head at 16:1 ratio. A crank rate of 12 turns in 10 seconds yields a head speed of 1152 RPM.

Item No.	Description
CENTFG1	Hand Centrifuge



Centrifuge Tubes, Self-Standing, PP/HDPE

Polypropylene tubes include a convenient flat bottom so they stand on their own, a large white frosted labeling area, silk screen graduations, and HDPE leak-proof caps.

Autoclavable at 121°C and 15 psi for 30 minutes. Radiation sterilized. DNase, RNase, Pyrogen and latex-free. Maximum RCF 9000.

Item No.	Capacity (ml)	Cap Color	O.D. x Height (mm)	Quantity per pack
P10424	50 (Sterile)	Blue	29.2 x 117.3	500



Centrifuge Tubes, Conical Bottom, PP/HDPE

Polypropylene tubes include blue HDPE leak-proof screw caps. The tubes and caps feature specially-designed flat threads for vacuum-type closure that is leak-free at a pressure of >700mm Hg. Highly smooth hydrophobic internal surfaces minimize wall effect. Silk-screen graduations and a frosted surface make writing easier.

Autoclavable at 121°C and 15 psi for 30 minutes. Radiation sterilized. DNase, RNase, Pyrogen and latex-free. Maximum RCF 14000.

Amber colored tubes are suitable for light sensitive applications because they do not allow any light to pass through the samples.

Item No.	Capacity (ml)	Cap Color	O.D. x Height (mm)	Quantity per pack
P10402	15 (Sterile)	Blue	16.5 x 117.8	500
P10406	15 (Sterile Amber)	Blue	16.5 x 117.8	500
P10404	50 (Sterile)	Blue	29.2 x 114.3	500
P10408	50 (Sterile Amber)	Blue	29.2 x 114.3	500

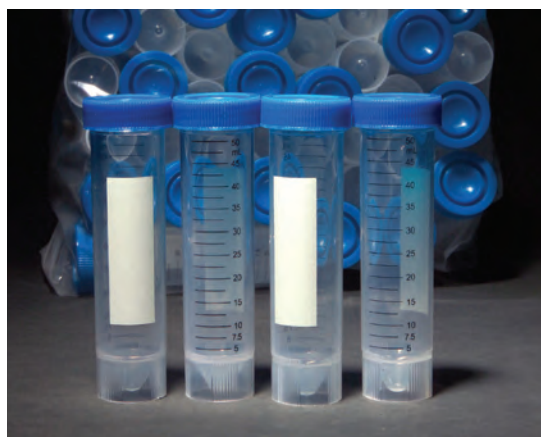

Centrifuge Tubes, Self-Standing, PP/HDPE

Polypropylene tubes feature a convenient flat bottom so they stand on their own. Include blue HDPE leak-proof screw caps, silk-screen black graduations and a large white marking spot. Tubes are graduated from 5 to 50ml with graduation intervals of 2.5ml.

Autoclavable at 121°C and freezable to -45°C. Steam sterilized. Maximum RCF 9000.

Item No.	Capacity (ml)	O.D. x Height (mm)	Quantity per pack	Quantity per case
D1002	50 (Sterile)	29.2 x 117.3	50	500

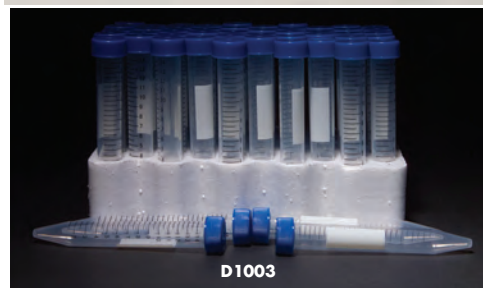
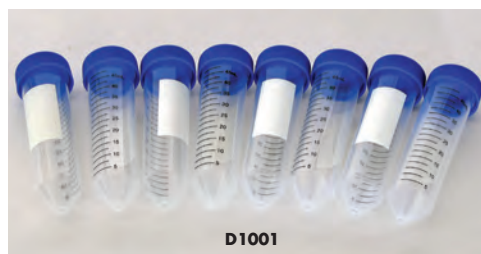

Centrifuge Tubes, Conical Bottom, PP/HDPE

Polypropylene tubes include blue HDPE leak-proof screw caps, silk-screen black graduations and a large white marking spot. Available in 15ml capacity (racked) or 50ml capacity (bulk in a poly bag).

15ml tubes are graduated from 2 to 14ml with graduation intervals of 0.5ml. 50ml tubes are graduated from 5 to 47.5ml with graduation intervals of 2.5ml.

Autoclavable at 121°C and freezable to -45°C. Steam sterilized. Maximum RCF 9000.

Item No.	Capacity (ml)	O.D. x Height (mm)	Quantity per pack	Quantity per case
D1003	15 (Sterile)	16.5 x 117.8	50	500
D1001	50 (Sterile)	29.2 x 114.3	50	500



Centrifuge Tubes, Racked, Conical Bottom, PP/HDPE

Centrifuge tube and rack sets are a convenient solution for organizing and storing conical bottom tubes. Racks are made of expanded polystyrene (EPS) and include holes arranged in a zigzag format for easy dispensing. Racks contain 50 of the 15ml tubes or 25 of the 50ml tubes. Sterile tubes are available in Clear or Amber styles.

Please refer to our 'Centrifuge Tube, Conical Bottom, PP/HDPE' presentation for a detailed listing of tube specifications.

Item No.	Capacity (ml)	Height (mm)	Quantity per pack
P10412	15 (Sterile, Racked)	125	50 pcs x 10 Racks
P10414	15 (Sterile Amber, Racked)	125	50 pcs x 10 Racks
P10416	50 (Sterile, Racked)	120	25 pcs x 20 Racks
P10418	50 (Sterile Amber, Racked)	120	25 pcs x 20 Racks

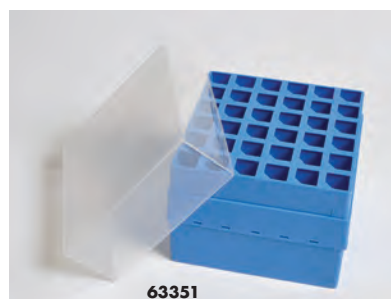

Centrifuge Tube Boxes, Economy, PP

Rugged, autoclavable centrifuge tube boxes can be used at temperatures of -90°C to 121°C. Racks hold 36 each 15ml tubes, or 16 each 50ml tubes, and feature a clear lid for easy identification of contents.

Item No.	Tube Capacity (ml)	Places	L x W x H (mm)	Quantity per pack
63351	15	36 (6 x 6 array)	145 x 145 x 125	4
63352	50	16 (4 x 4 array)	145 x 145 x 125	4



Micro Pestles, PP

These double-ended polypropylene micro pestles feature one end that fits 1.5ml microcentrifuge tubes and another end that fits 0.5ml tubes. Autoclavable. Micro pestles are excellent for resuspending bacterial cells and precipitates of nucleic acids or proteins, and are useful for tissue grinding.

Item No.	Description	Quantity per pack
81441	Micro Pestles for 1.5ml and 0.5ml tubes	12

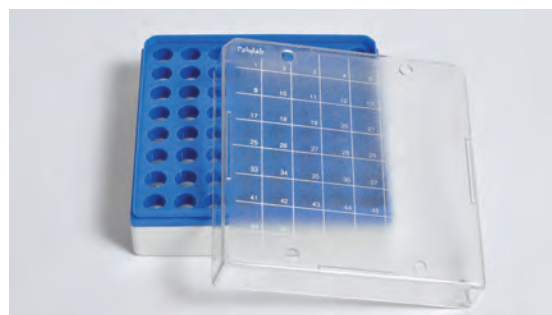

Microcentrifuge Tube Storage Boxes, PC

These rugged autoclavable storage boxes are molded in polycarbonate, and can be used at temperatures of -150°C to 121°C. Designed to hold 100 each 0.5ml microcentrifuge tubes, or 64 each 1.5ml tubes. The numbered grid on transparent lid is keyed in one position to prevent misalignment. Lid accepts writing with a marker. Not recommended for use with liquid-phase liquid nitrogen.

Item No.	Tube Capacity (ml)	Places	L x W x H (mm)	Quantity per pack
63213	0.5	100 (10 x 10 array)	133 x 133 x 52	4
63214	1.5	64 (8 x 8 array)	133 x 133 x 52	4



3-Prong Heavy Duty Extension Clamp with Stainless Steel Rod

This extension clamp features heavy-duty electroplated zinc alloy construction and dual prong adjustments. The 5" long extension rod is constructed of stainless steel. Prongs open to about 4", have a recommended maximum grip size of about 3.25", and feature double keyed spring-type adjustment screws. Prongs are covered with non-slip PVC sleeves. Overall length is 10.75".

Item No.	Description	Maximum Use Temperature
CLHD03	3-Prong Heavy Duty Extension Clamp	80°C



ECSIL2

3-Prong Extension Clamps with Boss Head

Our deluxe line of 3-prong extension clamps are constructed of pressure die-cast zinc alloy and are chrome-plated. Prongs open to about 3", have a recommended maximum grip size of about 2.25", and feature double keyed spring-type adjustment screws. Boss head clamp can swing freely, is lockable at any angle up to 360°, and can be used with rods up to 19mm.

Item No.	Description	Maximum Use Temperature
ECPVC2	3-Prong Extension Clamp with Boss Head, PVC coated grips	80°C
ECSIL2	3-Prong Extension Clamp with Boss Head, Silicone coated grips	280°C



ECPVC1



3-Prong Universal Clamp with Holder

Clamp features vinyl coated 3-prong jaws that open up to 2.25" wide. Includes fiberglass sleeves and a clamp holder that can be rotated 360°.

Item No.	Description	Maximum Use Temperature
ECBH01	3-Prong Universal Clamp with Clamp Holder	80°C



ECSIL1

3-Prong Extension Clamps with Rod

Our deluxe line of 3-prong extension clamps are constructed of pressure die-cast zinc alloy and are chrome-plated. Prongs open to about 3", have a recommended maximum grip size of about 2.25", and feature double keyed spring-type adjustment screws. Extension rod is 8.25" long, 5/16" O.D., with an overall length of 12.75".

Item No.	Description	Maximum Use Temperature
ECPVC1	3-Prong Extension Clamp with Rod, PVC coated grips	80°C
ECSIL1	3-Prong Extension Clamp with Rod, Silicone coated grips	280°C



3-Prong Extension Clamp with Steel Rod

Features a 3-prong die-cast clamp attached to a chrome-plated steel rod. Prongs are covered with rubber sleeves. Overall length is 10".

Item No.	Description	Maximum Use Temperature
ECLJ03	3-Prong Extension Clamp with Steel Rod	60°C



2-Prong Burette Clamps with Extension Rod

Our deluxe line of 2-prong burette clamps are made of pressure die-cast zinc alloy and are chrome plated. Adjustable to hold up to 60mm O.D. burettes, these clamps feature a spring-type adjustment key. Extension rod is 8.25" long, 5/16" O.D., with an overall length of 12.75".

Item No.	Description	Maximum Use Temperature
CLCORK1	2-Prong Burette Clamp with Extension Rod, Cork coated grips	60°C
CLPVC1	2-Prong Burette Clamp with Extension Rod, PVC coated grips	80°C
CLSIL1	2-Prong Burette Clamp with Extension Rod, Silicone coated grips	280°C



CLCORK1



CLSIL1



CLPVC1

2-Prong Burette Clamps with Boss Head

Our deluxe line of 2-prong burette clamps are made of pressure die-cast zinc alloy and are chrome plated. Adjustable to hold up to 60mm O.D. burettes, these clamps feature a spring-type adjustment key. Boss head clamp can swing freely and is lockable at any angle up to 360°, and can be used with rods up to 19mm.



CLCORK2



CLPVC2



CLSIL2

Item No.	Description	Maximum Use Temperature
CLCORK2	2-Prong Burette Clamp with Boss Head, Cork coated grips	60°C
CLPVC2	2-Prong Burette Clamp, with Boss Head, PVC coated grips	80°C
CLSIL2	2-Prong Burette Clamp, with Boss Head, Silicone coated grips	280°C

2-Prong Extension Clamp with Steel Rod

Features a 2-prong die-cast clamp attached to a chrome-plated steel rod. Jaws are lined with cork. Overall length is 8".



Item No.	Description	Maximum Use Temperature
CLEX01	2-Prong Extension Clamp with Steel Rod	60°C



CLBURDS



CLBURDD

Deluxe Burette Clamps

Deluxe burette clamps are die-cast from aluminum and feature black rubber sleeves for firm gripping of burettes. The adjustable clamps hold up to 30mm O.D. burettes which are held in place by the pressure created by the springs. For use with rods up to 19mm diameter.

Item No.	Description
CLBURDS	Deluxe Burette Clamp, Single
CLBURDD	Deluxe Burette Clamp, Double



Burette Clamps, PP

These polypropylene burette clamps are completely corrosion-proof. The spring-loaded jack in the middle provides a vice-like grip on the burette and prevents it from slipping. Two tapered wedges are included to ensure firm grip on 1/2" or 3/8" diameter rods.

Item No.	Description	Quantity per pack
45101	Burette Clamp, PP, Single	12
45102	Burette Clamp, PP, Double	6



CLBUR1N



CLBUR2N

Burette Clamps

These clamps are constructed from aluminum and feature PVC covered spring jaws. Available in single and double versions, these clamps accept burettes up to 35mm O.D., and can be used with support rods up to 1/2" O.D.

Item No.	Description
CLBUR1N	Burette Clamp, Single
CLBUR2N	Burette Clamp, Double



Lincoln-Type Burette Clamp

This zinc-plated stamped steel burette clamp has a steel thumbscrew and can be used with rods up to 3/4" in diameter. The distance between the two burettes is 7-1/4" (18.4cm).

Item No.	Description
CLLB02	Lincoln-Type Burette Clamp



4-Prong Extension Clamp with Boss Head

Features a 4-prong die-cast clamp attached to a chrome-plated steel rod. Jaws are lined with cork. Overall length is 8".

Item No.	Description	Maximum Use Temperature
CLFCORK2	4-Prong Extension Clamp with Boss Head	60°C



Labware Clamps

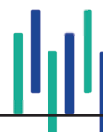

Clamp with Hook

Clamp with Hook can be rotated and locked in any position. Ideal for supporting suspended thermometers, drying tubes, etc. The clamp attaches to rods up to 13mm (1/2") O.D.

Item No.	Description
CLHK01	Clamp With Hook



Thermometer Clamp

Thermometer Clamp features an adjustable 360° rotating jaw for suspending thermometers. The clamp attaches to rods up to 13mm (1/2") O.D.

Item No.	Description
THCL01	Thermometer Clamp



Clamp Holder, Cast Aluminum

For rods to 19mm in diameter. Cast aluminum body with steel thumb screws.

Item No.	Description
RCLBH1	Clamp Holder, Cast Aluminum, Steel Thumb Screws



Swivel Clamp Holder

Plated steel double clamp. Accepts rods up to 3/4" diameter (19 mm). One clamp can be rotated 360° along its axis and locked in any position. Length across clamps is 4.5".

Item No.	Description
CLMS01	Swivel Clamp Holder



Burette Clamp with Boss Head, Coated Jaws

Excellent for holding small objects. The jaws open from 15mm to 45mm (1/2" to 1 3/4"). The clamp attaches to rods up to 13mm (1/2") O.D. Jaws can be rotated and locked at any angle. Jaws are covered with PVC sleeves.

Item No.	Description
COBR3-FR	Burette Clamp with Boss Head, Coated Jaws



Burette Clamp with Boss Head, Uncoated Jaws

Excellent for holding small objects. The jaws open from 15mm to 45mm (1/2" to 1 3/4"). The clamp attaches to rods up to 13mm (1/2") O.D. Jaws can be rotated and locked at any angle.

Item No.	Description
COBR3-U	Burette Clamp with Boss Head, Uncoated Jaws



Clamp Holder, Brass

For rods up to 19mm in diameter. Brass body with brass thumb screws.

Item No.	Description
RCLBH2	Clamp Holder, Brass Body, Brass Thumb Screws



NEW PRODUCT

Clamp Holder, Right Angle

Cast aluminum clamp holder for use with rods up to 19mm in diameter. For use when clamping at 90° is required. This clamp features a min to max grip range of 0-21mm and a v-groove bearing length of 55mm.

Item No.	Description
RTCLMP1	Clamp Holder, Right Angle



C-Clamps

Our clamps feature strong cast iron frames and a screw-thread mechanism that provides a sturdy grip.

Item No.	Description
CLMPC2	C-Clamp, 2" jaw opening
CLMPC3	C-Clamp, 3" jaw opening
CLMPC4	C-Clamp, 4" jaw opening
CLMPC5	C-Clamp, 5" jaw opening
CLMPC6	C-Clamp, 6" jaw opening



Hook Collar Clamps

Plated steel collar clamps feature thumbscrews and hooks for suspending pulleys, balances, etc. from support rods or crossbars.

Item No.	Description
HKCL01	Hook Collar Clamp, for 1/2" diameter rods
HKCL02	Hook Collar Clamp, for 3/4" diameter rods



TTCL02



TTCL03

Test Tube Clamps

Self-closing, available in brass wire or steel wire with brass finish.

Item No.	Description
TTCL01	Test Tube Clamp, Brass Wire, With Finger Grips
TTCL02	Test Tube Clamp, Brass Wire, Without Finger Grips
TTCL03	Test Tube Clamp, Steel Wire, Brass Finish, With Finger Grips
TTCL04	Test Tube Clamp, Steel Wire, Brass Finish, Without Finger Grips



Mohr's Pinchcock Tubing Clamps

Pinchcock tubing clamps are made of zinc-plated steel wire.

Item No.	Description
CLMP01	Mohr's Pinchcock Clamp, for 10mm diameter tubing
CLMP02	Mohr's Pinchcock Clamp, for 13mm diameter tubing
CLMP03	Mohr's Pinchcock Clamp, for 16mm diameter tubing



Test Tube Clamp, Wooden

This test tube clamp is 18cm (approx. 7") in length and will accommodate test tubes from 12 to 25mm in diameter.

Item No.	Description
TTCW01	Test Tube Clamp, Wooden



Screw Compressor Tubing Clamps

Swivel-type tubing clamps are made of zinc-plated steel wire.

Item No.	Description
HSCOP1	Screw Compressor Tubing Clamp, opens to 3/4"
HSCOP2	Screw Compressor Tubing Clamp, opens to 1"



Vigreux Distilling Columns, 24/40 Joint

A Vigreux column is a type of air condenser where the simple tube has been modified to include an abundance of downward-pointing indentations. This dramatically increases the surface area per unit length of the condenser. Socket is 24/40.

Item No.	Description
CDV200	Condenser, Vigreux, 200mm, 24/40 Joint
CDV300	Condenser, Vigreux, 300mm, 24/40 Joint
CDV400	Condenser, Vigreux, 400mm, 24/40 Joint
CDV500	Condenser, Vigreux, 500mm, 24/40 Joint



ADTHW-24



ADB105-24

Adapters, 3-Way, 24/40 Joint

3-Way adapter has a 75° angle sidearm with inner joints on the sidearm and bottom and an outer joint on the top. Inclined adapter has a 105° angle sidearm with outer joints on the sidearm and top and an inner joint on the bottom. Both adapters have 24/40 joints.

Item No.	Description
ADTHW-24	Adapter, 3-Way, 24/40 Joint
ADB105-24	Adapter, Inclined, 105°, 24/40 Joint



ADV160-24



ADVS01-24

Adapters, Vacuum

Vacuum adapters have 24/40 joints. Bent adapter has a 105° angle between the top outer joint and bottom inner joint. Straight adapter has a top outer joint and bottom inner joint. Both adapters have 24/40 joints and include a 3/8" hose connector.

Item No.	Description
ADV160-24	Vacuum Adapter, Bent, 24/40 Joint
ADVS01-24	Vacuum Adapter, Straight, 24/40 Joint



Condensers, Graham, 24/40 Joint

Graham condenser is designed for use in distillation applications. Constructed of borosilicate glass, this condenser has a coiled inner tube to provide additional surface area for highly efficient cooling. Socket is 24/40 with a screw thread connector.

Item No.	Description
CNG200	Condenser, Graham, 200mm, 24/40 Joint
CNG300	Condenser, Graham, 300mm, 24/40 Joint
CNG400	Condenser, Graham, 400mm, 24/40 Joint
CNG500	Condenser, Graham, 500mm, 24/40 Joint



Condensers, Liebig, 24/40 Joint

Liebig condensers are used to cool and condense hot vapor as part of a distilling apparatus. This condenser has a straight inner tube that the condensing vapor passes through, and a larger outer jacket that cooling water passes through. Socket is 24/40 with a screw thread connector.

Item No.	Description
CNL200	Condenser, Liebig, 200mm, 24/40 Joint
CNL300	Condenser, Liebig, 300mm, 24/40 Joint
CNL400	Condenser, Liebig, 400mm, 24/40 Joint
CNL500	Condenser, Liebig, 500mm, 24/40 Joint



Economical Bowls, Stainless Steel

Economical bowls are constructed from 204Cu stainless steel for corrosion resistance at a lower cost. Bowls feature a polished mirror surface for easy mixing and cleaning. Can withstand temperatures up to 760°C (1400°F). Meets NSF standards.



Item No.	Capacity (QT)	Diameter (in)	Height (in)
BWE075	0.75	6 1/2	2
BWE150	1.5	7 3/4	2 3/4
BWE300	3	9	4 1/4
BWE400	4	10 11/16	3 1/2
BWE500	5	11 3/4	4
BWE800	8	13 1/2	4 1/2
BWE1300	13	16	5 1/2
BWE1600	16	17 1/2	5 3/4
BWE2000	20	19	6

Mixing Bowls, Stainless Steel

Mixing bowls are constructed from 304 stainless steel for increased heat resistance. Bowls feature rounded corners, and polished mirror surface for easy mixing and cleaning. Can withstand temperatures up to 800°C (1472°F). Meets NSF standards.



Item No.	Capacity (Qt)	Diameter (in)	Height (in)
BMX075	0.75	6 1/4	2 3/8
BMX150	1.5	7 3/4	3
BMX300	3	9 3/8	4
BMX400	4	10 3/8	4 1/4
BMX500	5	11 3/4	4 1/2
BMX800	8	13 1/4	5 3/8
BMX1300	13	16	6
BMX2000	20	19	6
BMX3000	30	21 5/8	7 7/8

Crucibles, Nickel

Unibody construction from sheet nickel, polished inside and out. Can withstand temperatures up to 600°C. Covers included.



Item No.	Capacity (ml)	Height (mm)	Top Outside Diameter (mm)	Quantity per pack
NCR015	15	29	32	1
NCR025	25	39	36	1
NCR050	50	47	45	1
NCR100	100	56	57	1



Utility Tanks with Lid (Stock Pot), Stainless Steel

Utility tanks (stock pots) are constructed from unsealed, medium gauge 304 stainless steel. Exceptional for use with gas, electric, or even induction style stoves. Tank features heat-resistant handles, and encapsulated-aluminum bottom with three layers for even heat distribution and less energy consumption. Cover is included.

Item No.	Capacity (L)	Diameter (cm)	Height (cm)
STKPT06	6	20	19
STKPT11	11	24	24
STKPT17	17	28	28
STKPT26	26	32	32
STKPT37	37	36	36
STKPT50	50	40	40
STKPT71	71	45	45
STKPT98	98	50	50
STKPT169	169	60	60

Crucibles, Stainless Steel

Unibody construction from Type 304 stainless steel. Can withstand temperatures from -180° to 800°C. Covers included.



Item No.	Capacity (ml)	Height (mm)	Top Outside Diameter (mm)	Quantity per pack
SSR015	15	34	32	1
SSR020	20	34	33	1
SSR025	25	34	36	1
SSR030	30	38	39	1
SSR050	50	48	46	1
SSR100	100	55	57	1



CTSP09

Crucible Tongs

Tongs have an overall length of 9" and include riveted joints and serrated tips.

Item No.	Description
CTSP09	Crucible Tongs, Plated Steel
CTOS09	Crucible Tongs, Oxidized Steel
CTBR09	Crucible Tongs, Brass
CTSS09	Crucible Tongs, Stainless Steel



Crucibles, Gooch Filter with Cover, Porcelain

Gooch crucibles have a perforated bottom and include covers. Crucibles are glazed on inner and outer surfaces except for the outside bottom and rim. Used for determination of total suspended solids.

Autoclavable. Withstand temperatures to 1150°C. To prevent thermal stress cracks, we strongly recommend a heating/cooling rate not exceeding 200°C per hour. United porcelain crucibles offer excellent resistance to acids and alkalies except for hydrofluoric acid.

Item No.	Capacity (ml)	For Filter Paper Dia. (mm)	Height x Top O.D. (mm)	Quantity per pack
JGC015	15	15 - 16	32 x 29	6
JGC030	30	20 - 21	45 x 36	6
JGC050	50	23 - 24	49 x 40	6
JGC140	140	30	83 x 55	1

Crucibles, Tall Form, Glass

Tall form clear quartz glass crucibles are ideal for analytical applications that require ashing of samples. Quartz material offers low expansion, dimensional stability, and thermal shock resistance. Can withstand a continuous operating temperature of 1050°C (1922°F). Lids are also manufactured from quartz and sold separately.



Item No.	Capacity (ml)	Height (mm)	Top Outside Diameter (mm)	Lid Item No.	Quantity per pack
CQP015	15	35	40	CQP015-L	1
CQP025	25	45	45	CQP025-L	1
CQP050	50	55	50	CQP050-L	1

Crucibles, Glass

Clear quartz glass crucibles are useful for analytical applications that require ashing of samples. Quartz material offers low expansion, dimensional stability, and thermal shock resistance. Can withstand a continuous operating temperature of 1050°C (1922°F). Lids are also manufactured from quartz and sold separately.



Item No.	Capacity (ml)	Height (mm)	Top Outside Diameter (mm)	Lid Item No.	Quantity per pack
CGQ015	15	25	41	CGQ015-L	1
CGQ025	25	28	47	CGQ025-L	1
CGQ050	50	37	57	CGQ050-L	1
CGQ080	80	45	67	CGQ080-L	1
CGQ100	100	48	70	CGQ100-L	1
CGQ150	150	51	82	CGQ150-L	1



Crucibles, Tall Form with Cover, Porcelain

Tall form crucibles include covers. Crucibles are glazed on inner and outer surfaces except for the outside bottom and rim.

Autoclavable. Withstand temperatures to 1150°C. To prevent thermal stress cracks, we strongly recommend a heating/cooling rate not exceeding 200°C per hour. United porcelain crucibles offer excellent resistance to acids and alkalies except for hydrofluoric acid.

Item No.	Capacity (ml)	Height (mm)	Top Outside Diameter (mm)	Quantity per pack
JCT013	1.3	15	15	6
JCT005	5	20	24	6
JCT010	10	26	31	6
JCT015	15	29	35	6
JCT025	25	32	40	6
JCT030	30	37	43	6
JCT040	40	40	50	6
JCT050	50	43	53	6
JCT100	100	54	65	6
JCT250	250	72	88	6



Crucibles, Wide Form with Cover, Porcelain

Wide form crucibles include covers. Crucibles are glazed on inner and outer surfaces except for the outside bottom and rim.

Autoclavable. Withstand temperatures to 1150°C. To prevent thermal stress cracks, we strongly recommend a heating/cooling rate not exceeding 200°C per hour. United porcelain crucibles offer excellent resistance to acids and alkalies except for hydrofluoric acid.

Item No.	Capacity (ml)	Height (mm)	Top Outside Diameter (mm)	Quantity per pack
JCL010	10	20	32	6
JCL020	20	26	41	6
JCL030	30	31	50	6
JCL050	50	37	61	6
JCL100	100	46	76	6
JCL150	150	52	84	6
JCL250	250	60	102	6



Properties of High Alumina Products

United's high alumina wares are made of 99.7% pure aluminum oxide. Highly resistant to chemical attack, this alumina-ceramic ware is especially useful to chemists, metallurgists and others involved in high temperature work demanding contamination-free results.

High alumina ware is highly refractory, meant for use in reducing and oxidizing atmospheres. It is inert in hydrogen and carbonaceous atmospheres and offers

high resistance to alkalis and other fluxes. Suitable for glass melting, including borosilicate glass.

Recommended for use with refractory metals such as Molybdenum, Platinum, Rhodium, Tungsten, Tantalum and Iridium. High alumina labware temperature change rate should not exceed 150°C/hour.



Crucibles, Tall Form, High Alumina

Tall form, unglazed, 99.7% alumina crucible. Maximum use temperature is 1750°C.

Item No.	Capacity (ml)	Height (mm)	Top Outside Diameter (mm)	Quantity per pack
JAH010	10	33	30	1
JAH020	20	36	39	1
JAH050	50	47	52	1
JAH100	100	62	65	1

Crucibles, Cylindrical Form, High Alumina

Cylindrical form, unglazed, 99.7% alumina crucible. Maximum use temperature is 1750°C.

Item No.	Capacity (ml)	Height (mm)	Top Outside Diameter (mm)	Quantity per pack
JAY010	10	29	28	1
JAY020	20	40	32	1
JAY030	30	45	35	1
JAY050	50	56	41	1



Crucibles include a molded-in porous disc with stable porosity and consistent flow rate.

Crucibles, Conical Form, High Alumina

Conical form, unglazed, 99.7% alumina crucible. Maximum use temperature is 1750°C.

Item No.	Capacity (ml)	Height (mm)	Top Outside Diameter (mm)	Quantity per pack
JAC020	20	42	33	1
JAC030	30	43	48	1
JAC050	50	53	46	1
JAC100	100	86	64	1

Crucibles, Porous Bottom, Porcelain

Crucibles with porous bottom have a molded-in porous disc with stable porosity and consistent flow rate. Available with very fine (1.2 µm), fine (5 µm), and medium (15 µm) pore diameters. Glazed inside and out, except for outside bottom and rim. Autoclavable.

Item No.	Capacity (ml)	Pore Diameter (micron / µm)	Top O.D. x Bottom O.D. (mm)	Qty per pack
JCP25012	25	1.2	36 X 24	8
JCP25050	25	5.0	36 X 24	8
JCP25150	25	15.0	36 X 24	8



Cryo Vials, Internal Threaded, Sterile, PP

Cryo vials are designed for storage of samples as low as -196°C^* . DNase, RNase, and Pyrogen-free. Radiation sterilized. Polypropylene vials include a cap embedded with a non-toxic silicone O-ring for a secure seal, a large white frosted labeling area, and silk screen graduations. Star base and round base vials have an internal U-shaped bottom. Self-standing star base vials are designed for one-handed use with a support rack.

*Not recommended for use in the liquid phase of liquid nitrogen. Can be used in vapor phase of liquid nitrogen.

Item No.	Description	Outer Diameter (mm)	Height (mm)	Quantity per pack
P60109	Cryo Vial, 1.8ml Star Base	12.3	47.5	500
P60110	Cryo Vial, 1.8ml Round Base	12.3	46.2	500
P60112	Cryo Vial, 4.5ml Star Base	12.3	90.3	250
P60113	Cryo Vial, 4.5ml Round Base	12.3	89.0	250



Cryo Vials, External Threaded, Sterile, PP

Cryo vials are designed for storage of samples as low as -196°C^* . DNase, RNase, and Pyrogen-free. Radiation sterilized. Polypropylene vials feature a large white frosted labeling area, silk screen graduations, and a leak-proof HDPE cap. Skirted base vials have an internal flat bottom. Star base and round base vials have an internal U-shaped bottom. Self-standing star base vials are designed for one-handed use with a support rack.

*Not recommended for use in the liquid phase of liquid nitrogen. Can be used in vapor phase of liquid nitrogen.

Item No.	Description	Outer Diameter (mm)	Height (mm)	Quantity per pack
P60102	Cryo Vial, 1.8ml Skirted Base	11.8	47.2	1000
P60116	Cryo Vial, 1.8ml Star Base	12	48.5	1000
P60117	Cryo Vial, 1.8ml Round Base	12	47.5	1000
P60103	Cryo Vial, 4.5ml Skirted Base	11.8	88	500
P60118	Cryo Vial, 4.5ml Star Base	12	91.5	500
P60119	Cryo Vial, 4.5ml Round Base	12	90.5	500



Cryo Coders for Skirted Base Vials, HDPE

Designed to fit onto the top of our skirted base externally threaded cryogenic vial closures. Provide quick visual identification of specific vials for ease in organizing inventory. Available in a range of colors. Compatible with P60102 and P60103 skirted base cryo vials.

Item No.	Color	Quantity per pack
P60104W	White	100
P60104B	Blue	100
P60104R	Red	100
P60104Y	Yellow	100
P60104G	Green	100



Cryo Coders for Star and Round Base Vials, HDPE

Designed to fit onto the top of our star and round base cryogenic vial closures. Provide quick visual identification of specific vials for ease in organizing inventory. Available in a range of colors. Compatible with all of our cryo vials except P60102 and P60103 skirted base cryo vials.

Item No.	Color	Quantity per pack
P60114W	White	100
P60114B	Blue	100
P60114R	Red	100
P60114Y	Yellow	100
P60114G	Green	100



Cryo Cube Boxes, PP



66501 has a 9 x 9 array to hold 81 1.5 to 2.0ml microtubes or 1.0 to 2.0ml cryogenic vials. Each pack includes two yellow and two blue Cryo Boxes.

66502 has a 10 x 10 array to hold 100 1.5 to 2.0ml microtubes or 1.0 to 2.0ml cryogenic vials. Each pack includes two yellow and two blue Cryo Boxes.

Manufactured of polypropylene, these autoclavable boxes are stackable for sample storage in 1.5 to 2.0ml microtubes and 1.0 to 2.0ml cryogenic vials. Boxes can be used at temperatures from -90°C to 121°C.

Boxes feature a hinged lid connected to the base and a locking system to ensure secure closure. A molded alpha-numeric grid allows for easy identification of samples.

Dimensions of cryo boxes are designed to be compatible with vertical, horizontal, and drawer style freezer racks.

Each pack includes two yellow boxes and two blue boxes.

Item No.	Description	Places	L x W x H (mm)	Qty per pack
66501	Cryo Cube Box, PP	81 (9 x 9 array)	128 x 128 x 54	4
66502	Cryo Cube Box, PP	100 (10 x 10 array)	139 x 139 x 54	4



Cryo Cube Box includes a locking system to ensure secure closure.

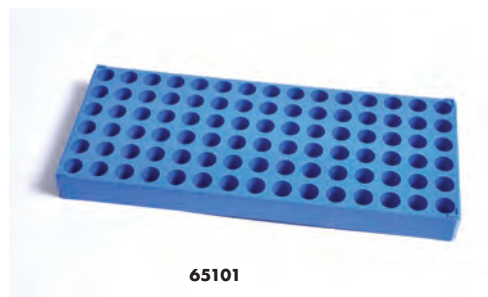

65101

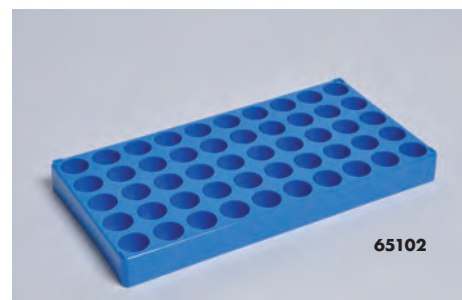

65102



Cryo Storage Box, PP

Cryo storage boxes are designed for storage of samples as low as -90°C. Hold both internal and external threaded cryogenic vials as well as storage vials. Autoclavable.

These stackable boxes provide a small, space-efficient storage system within a freezer. Include a transparent hinged lid with a secure locking closure and a numbered and lettered grid for easy identification of contents. Designed to hold up to 100 vials in a 10 x 10 array.

Item No.	Fits vial sizes (ml)	Places	L x W x H (mm)	Quantity per pack
P20607	1.5, 2.0 Microtubes, 1.0, 1.8 Cryo vials	100	140 x 140 x 55	4

Vial Racks, PP

Sturdy, economical, and convenient racks for samples stored in vials. Autoclavable at 120°C for 20 minutes. Can be stacked when not filled, for easy storage. Each well features a drainage hole at the bottom.

Item No.	Well Dia.	Places (array)	L x W x H (mm)	Vial Capacity	Quantity per pack
65101	17mm	90 (15 x 6)	354 x 145 x 30	8ml	5
65102	29mm	50 (10 x 5)	203 x 102 x 24	20ml	5

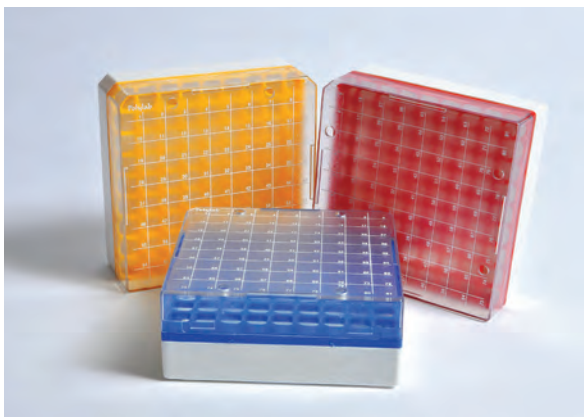

Cryo/Freezer Boxes, PC

Manufactured of strong polycarbonate, these boxes are ideal for compact storage of 2.0 or 5.0ml cryogenic vials. Boxes can be used at temperatures from -196°C to 121°C and are autoclavable.

Transparent lids have a numbered grid for sample identification. Frosted surface area is suitable for writing with markers.

Dimensions of cryo boxes are designed to be compatible with vertical, horizontal, and drawer style freezer racks.

66301 includes two red boxes, one blue box, and one yellow box. 66302 includes two red boxes and two blue boxes. 66303 includes an assortment of red, yellow, and blue colored boxes.

Item No.	Description	Places	L x W x H (mm)	Qty per pack
66301	Cryo Rack for 2ml vials	81 (9 x9 array)	133 x 132 x 54	4
66302	Cryo Rack for 5ml vials	81 (9 x9 array)	133 x 132 x 97	4
66303	Cryo Rack for 2ml vials	100 (10 x 10 array)	148 x 147 x 54	4

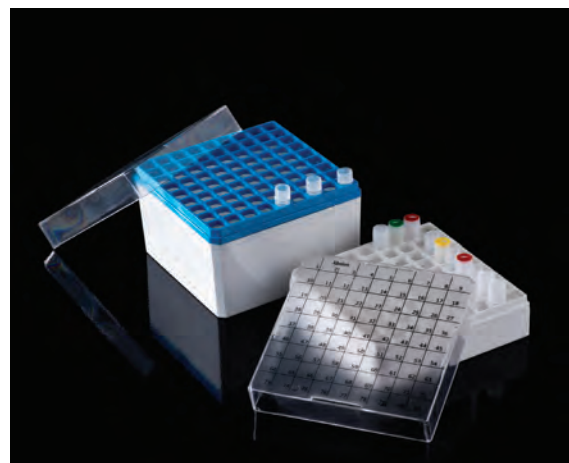

Cryo Storage Box, PC

Cryo storage boxes are designed for storage of samples as low as -196°C*. Hold both internal and external threaded cryogenic vials. Autoclavable.

These boxes provide a small, space-efficient storage system within a freezer. The transparent lid features a numbered grid for easy identification of contents. Designed to hold up to 81 vials in a 9 x 9 array.

*Not recommended for use in the liquid phase of liquid nitrogen. Can be used in vapor phase of liquid nitrogen.

Item No.	Fits vial sizes (ml)	Places	L x W x H (mm)	Quantity per pack
P20602	1 and 1.8	81	133 x 132 x 54	4
P20603	4.5	81	133 x 132 x 97	4



Cryo Rack includes anti-skid rubber feet.

Cryo Rack, PC

This durable and autoclavable Cryo rack can hold 50 vials. Unique design at the bottom of each well lets vials be unscrewed without removing them from the rack. The rack features an alpha-numeric index, and anti-skid rubber feet.

Item No.	Description
66201	Cryo Rack, Polycarbonate



RIA Vials and Cap

RIA vials are generally used in radioimmunoassay - a scientific method used to test antigens without the need to use a bioassay.

The polypropylene vials are translucent and can withstand 3000 RCF during centrifugation. Can be used with common acids, alkalies, and solvents at room temperature. Autoclavable.

The polystyrene vials are transparent and can withstand 1400 RCF during centrifugation. Can be used with mild bases and weak acids, but not organic solvents. Non-autoclavable.

Caps are sold separately and are compatible with both versions of vials.

Item No.	O.D. (mm)	Height (mm)	Material	Quantity per pack
P10301	12	75	Polypropylene	500
P10303	12	75	Polystyrene	500
RIA Vial Cap				
P10304	12		HDPE	500



Labware Cylinders



Graduated Cylinders, Glass, Class A, Batch Certified



Cylinders comply with ASTM E1272, Class A standards, batch certified.

Double metric scale, calibrated to contain. Borosilicate glass cylinders with pour spouts feature heavy uniform wall tubing and strong, stable, hexagonal bases. All cylinders come with bumper guards.

Item No.	Capacity (ml)	Graduation Interval (ml)	Tolerance (\pm ml)	Quantity per pack
CY3021-10	10	0.2	0.10	1
CY3021-25	25	0.5	0.17	1
CY3021-50	50	1.0	0.25	1
CY3021-100	100	1.0	0.50	1
CY3021-250	250	2.0	1.0	1
CY3021-500	500	5.0	2.0	1
CY3021-1000	1000	10.0	3.0	1
CY3021-2000	2000	20.0	6.0	1



Each cylinder includes a batch calibration certificate.

Cylinders on this page are calibrated to contain. We also offer Class A cylinders that are calibrated to deliver. Please call for details.

Graduated Cylinders, Glass, Class A, Individually Certified



Cylinders comply with ASTM E1272, Class A, meets USP standards, individually serialized and certified.

Double metric scale, calibrated to contain. Borosilicate glass cylinders with pour spouts feature heavy uniform wall tubing and strong, stable, hexagonal bases. All cylinders come with bumper guards.

Item No.	Capacity (ml)	Graduation Interval (ml)	Tolerance (\pm ml)	Quantity per pack
CY3020-10	10	0.2	0.10	1
CY3020-25	25	0.5	0.17	1
CY3020-50	50	1.0	0.25	1
CY3020-100	100	1.0	0.50	1
CY3020-250	250	2.0	1.0	1
CY3020-500	500	5.0	2.0	1
CY3020-1000	1000	10.0	3.0	1
CY3020-2000	2000	20.0	6.0	1

Each cylinder includes an individually serialized certificate.





Labware Cylinders



Graduated Cylinders, Glass, Class A, Batch Certified, with Stopper

Cylinders comply with ASTM E1272, Class A standards, batch certified. Each cylinder includes a hollow glass stopper.

Double metric scale, calibrated to contain. Borosilicate glass cylinders feature heavy uniform wall tubing and strong, stable, hexagonal bases. All cylinders come with bumper guards.

Item No.	Capacity (ml)	Graduation Interval (ml)	Tolerance (\pm ml)	Quantity per pack
CY2981-10	10	0.2	0.10	1
CY2981-25	25	0.5	0.17	1
CY2981-50	50	1.0	0.25	1
CY2981-100	100	1.0	0.50	1
CY2981-250	250	2.0	1.0	1
CY2981-500	500	5.0	2.0	1
CY2981-1000	1000	10.0	3.0	1
CY2981-2000	2000	20.0	6.0	1



Each cylinder includes a batch calibration certificate.

Cylinders on this page are calibrated to contain. We also offer Class A cylinders that are calibrated to deliver. Please call for details.



Graduated Cylinders, Glass, Class A, Individually Certified, with Stopper

Cylinders comply with ASTM E1272, Class A, meets USP standards, individually serialized and certified. Each cylinder includes a hollow glass stopper.

Double metric scale, calibrated to contain. Borosilicate glass cylinders feature heavy uniform wall tubing and strong, stable, hexagonal bases. All cylinders come with bumper guards.

Item No.	Capacity (ml)	Graduation Interval (ml)	Tolerance (\pm ml)	Quantity per pack
CY2980-10	10	0.2	0.10	1
CY2980-25	25	0.5	0.17	1
CY2980-50	50	1.0	0.25	1
CY2980-100	100	1.0	0.50	1
CY2980-250	250	2.0	1.0	1
CY2980-500	500	5.0	2.0	1
CY2980-1000	1000	10.0	3.0	1
CY2980-2000	2000	20.0	6.0	1



Each cylinder includes an individually serialized certificate.





Graduated Cylinders, Plastic Base, Borosilicate Glass

Double metric scale, calibrated to contain. Borosilicate glass cylinders with pour spouts feature heavy uniform wall tubing and plastic hexagonal bases. All cylinders come with bumper guards.



Item No.	Capacity (ml)	Graduation Interval (ml)	Tolerance (\pm ml)	Quantity per pack
CY137-10	10	0.2	0.2	10
CY137-25	25	0.5	0.34	10
CY137-50	50	1	0.5	10
CY137-100	100	1	1.0	10
CY137-250	250	2	2.0	10

Graduated Cylinders, Class B, Borosilicate Glass

Cylinders comply with ASTM E1272, Class B standards.

Double metric scale, calibrated to contain. Borosilicate glass cylinders with pour spouts feature heavy uniform wall tubing and attached glass hexagonal bases. All cylinders come with bumper guards.



Item No.	Capacity (ml)	Graduation Interval (ml)	Tolerance (\pm ml)	Quantity per pack
CY3022-10	10	0.2	0.2	24
CY3022-25	25	0.5	0.34	18
CY3022-50	50	1	0.5	18
CY3022-100	100	1	1.0	12
CY3022-250	250	2	2.0	12
CY3022-500	500	5	4.0	8
CY3022-1000	1000	10	6.0	1
CY3022-2000	2000	20	12.0	1



Cylinder and Bottle Brush, Nylon Bristles

Designed for cleaning cylinders, bottles, and large test tubes. Features nylon bristles with a radial top mounted in twisted heavy gauge galvanized wire.

Item No.	Brush Length	Brush Diameter	Overall Length	Quantity per pack
CYBR20	7"	2.5"	20"	1

Measuring Cylinders, Class A, PMP

Polymethylpentene cylinders have glass-like clarity and feature easy-to-read molded in graduations. Hexagonally-shaped bases for extra stability. Large spouts for smooth flow of liquids during pouring. Autoclavable to 121°C.

Meets accuracy requirements of Class A under DIN 12681. Supplied with conformity test certificate that indicates batch number and year of production.



Item No.	Capacity (ml)	Graduation Interval (ml)	Tolerance (\pm ml)	Height (mm)	Quantity per pack
P50501	10	0.2	0.1	138	1
P50502	25	0.5	0.25	169	1
P50503	50	1	0.5	198	1
P50504	100	1	0.5	258	1
P50505	250	2	1	314	1
P50506	500	5	2.5	345	1
P50507	1000	10	5	411	1
P50508	2000	20	10	482	1

Measuring Cylinders, Class B, PMP

Polymethylpentene cylinders have glass-like clarity and feature easy-to-read molded in graduations. Hexagonally-shaped bases for extra stability. Large spouts for smooth flow of liquids during pouring. Autoclavable to 121°C.

Meets accuracy requirements of Class B under DIN 1261.



Item No.	Capacity (ml)	Graduation Interval (ml)	Tolerance (\pm ml)	Height (mm)	Quantity per pack
P50401	10	0.2	0.2	138	12
P50402	25	0.5	0.5	169	12
P50403	50	1	1	198	12
P50404	100	1	1	258	6
P50405	250	2	2	314	6
P50406	500	5	5	345	3
P50407	1000	10	10	411	3
P50408	2000	20	20	482	3

Conical Measuring Cylinders, PP

Our polypropylene conical measuring cylinders are ideal for measuring small quantities of reagents. They are autoclavable and have excellent contact clarity. The hexagonal base provides excellent stability to the cylinder, and the tapered spout enables easy pouring of reagents. Features easy-to-read raised graduations.



Item No.	Capacity (ml)	Graduation Interval (ml)	Height (mm)	Quantity per pack
81150	12	1	65	12
81151	25	1	70	12
81152	50	2	91	12
81153	125	5	121	12
81154	200	5	149	12



Labware Cylinders



Measuring Cylinders, Hexagonal Base, PP

Our polypropylene one-piece measuring cylinders have raised graduations for easy readability. They are autoclavable and have excellent contact clarity. The hexagonal base provides excellent stability to the cylinder, and the tapered spout enables easy pouring of reagents. Stated tolerances are the same as graduated intervals below.



Item No.	Capacity (ml)	O.D. (mm)	Height (mm)	Graduation Interval (ml)	Quantity per pack
80031	10	15	110	0.2	24
80032	25	19	170	0.5	12
80033	50	26	198	1	12
80034	100	34	210	1	12
80035	250	46	321	2	6
80036	500	56	361	5	4
80037	1000	72	375	10	3

Nessler Cylinders, Class A, Individually Certified, Borosilicate Glass

Nessler cylinders are used for comparison of color and turbidity between solutions or as reaction vessels. Made from borosilicate glass and calibrated to Class A standards. Include an optically plane bottom as well as markings for nominal stroke volume and halfway mark.

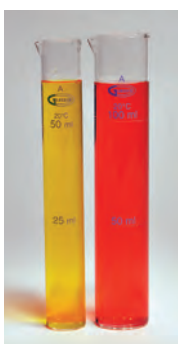

Item No.	Capacity (ml)	Volume Markings (ml)	Tolerance (\pm ml)	Quantity per pack
CGN050	50	25 and 50	0.4	10
CGN100	100	50 and 100	0.8	10



Hydrometer Rack, 12-Tube, PP

Sturdy polypropylene rack will hold 12 hydrometers or test tubes up to 20mm in diameter. Easy to assemble, and chemical resistant.

Item No.	Description
TTHP03	Test Tube/Hydrometer Rack, 12-Tube, PP

Measuring Cylinders, Round Base, PP

Our polypropylene one-piece measuring cylinders have raised graduations for easy readability. They are autoclavable and have excellent contact clarity. The broad round base provides good stability. Stated tolerances are the same as graduated intervals below.



Item No.	Capacity (ml)	O.D. (mm)	Height (mm)	Graduation Interval (ml)	Quantity per pack
CP0010	10	15	110	0.2	24
CP0025	25	19	170	0.5	12
CP0050	50	26	198	1	12
CP0100	100	34	210	1	12
CP0250	250	46	321	2	6
CP0500	500	56	361	5	4
CP1000	1000	72	375	10	3
CP2000	2000	90	473	20	2

Measuring Cylinder Sets, PP

A convenient set of seven graduated polypropylene cylinders in sizes 10ml, 25ml, 50ml, 100ml, 250ml, 500ml, and 1000ml.

Also available as a set of four in sizes 10ml, 25ml, 50ml and 100ml.

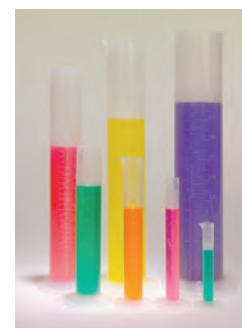

Item No.	Description
CPSET7	Plastic Graduated Cylinders, Set of 7
CPSET4	Plastic Graduated Cylinders, Set of 4

Hydrometer Cylinders, Borosilicate Glass

Made from heavy borosilicate glass, these cylinders have a beaded top with a pouring spout and a round base for stability.



Hydrometer cylinder shown with hydrometer.

Item No.	Capacity (ml)	O.D. x Height (mm)	Quantity per pack
HYC500	500	53 x 323	1
HYC600	600	53 x 409	1
HYC1000	1000	67 x 460	1
HYC1200	1200	67 x 473	1



Desiccators, Non-Vacuum, White Base, PP/PC

These autoclavable desiccators are made of polypropylene (PP) and polycarbonate (PC). Autoclavable at 120°C for 15 minutes.

The top dome, molded in rigid and transparent PC, gives a crystal-clear view of the sample. The knurled knob on the top provides easy handling of the dome.

The lower part is made of PP. An internal groove on the flange holds the silicon rubber O-ring. Vacuum grease should be applied on the flanges to make it airtight.

Item No.	Size	Flange OD/ID (mm)	Plate OD (mm)	Height (mm)	Maximum Clearance* (mm)	Qty per pack
55201	6" / 150mm	171/150	138	204	123	1
55202	8" / 200mm	232/199	190	257	166	1
55203	10" / 250mm	276/240	238	315	207	1
55208	12" / 300mm	340/300	295	405	255	1

* Maximum clearance above plate.



Desiccators, Vacuum, White Base, PP/PC

These autoclavable desiccators are made of polypropylene (PP) and polycarbonate (PC) and can hold a vacuum up to 740mm Hg for 24 hours without any greasing. Autoclavable at 121°C for 15 minutes.

The top dome, molded in rigid and transparent PC, gives a crystal-clear view of the sample. The knurled knob on the top provides easy handling of the dome.

The lower part is made of PP and includes a perforated PP desiccator plate. An internal groove on the flange holds the silicon rubber O-ring.

The PP stopcock accepts 1/4" I.D. tubing and has a self-lubricating PTFE plug. Use the three-way plug to create a vacuum, release a vacuum, or for shut-off.

Item No.	Size	Flange OD/ID (mm)	Plate OD (mm)	Height (mm)	Maximum Clearance* (mm)	Qty per pack
55204	6" / 150mm	171/150	138	204	123	1
55205	8" / 200mm	232/199	190	257	166	1
55206	10" / 250mm	276/240	238	315	207	1
55207	12" / 300mm	340/300	295	405	255	1

* Maximum clearance above plate.



HVP001



TUBEFK

Hand Vacuum Pump

Good quality, economical hand operated air/ is easy to operate. Each squeeze of the pump delivers approximately 15ml, and can be used to create vacuum of 50mm Hg, or air pressure of about 2 atm (standard atmosphere). Pump features a gauge along with a removable cap and elastic valve to provide quick vacuum release without dismantling the pump from the line. Recommended for general laboratory use for applications that do not require high or precise vacuums.

Item No.	Description
HVP001	Hand Vacuum Pump
TUBEFK	Tubing, Vacuum, 18 inch length



NEW PRODUCT

Hand Vacuum Pump, without Gauge

Good quality, economical hand operated air/vacuum pump is easy to operate. Each squeeze of the pump delivers approximately 15ml, and can be used to create vacuum of 50mm Hg, or air pressure of about 2 atm (standard atmosphere). Pump features a removable cap and elastic valve to provide quick vacuum release without dismantling the pump from the line. Recommended for general laboratory use for applications that do not require high or precise vacuums.

Item No.	Description
HVP001-N	Hand Vacuum Pump, without Gauge



Desiccator Plates with Small Holes, Porcelain

Plates include numerous 5mm diameter perforations. Also includes large hole in center. Glazed on one side.

Item No.	Diameter (mm)	Diameter of Holes (mm)	Diameter of Center Hole (mm)	Quantity per pack
JSD140	140	5	25	1
JSD190	190	5	25	1
JSD230	230	5	25	1



Desiccator Plates with Stand, Porcelain

Desiccators include three 16mm high feet. Glazed on top surface.

Item No.	Diameter (mm)	Number of Holes	Diameter of Holes (mm)	Quantity per pack
JDS095	95	3	30	1
JDS115	115	4	30	1
JDS142	142	5	30	1
JDS146	146	7	30	1
JDS190	190	7	30	1
JDS230	230	8	30	1



Desiccator Plates with Large Holes, Porcelain

Includes large hole in center and additional 6 to 10 holes depending on plate size. Glazed on one side.

Item No.	Dia. (mm)	Number of Holes	Dia. of Holes (mm)	Dia. of Center Hole (mm)	Quantity per pack
JDP140	140	6	35	35	1
JDP190	190	8	35	50	1
JDP230	230	10	35	50	1



Desiccators, Glass

These clear non-vacuum desiccators are manufactured from borosilicate glass and include a borosilicate glass lid with a molded-in knob. Clear glass provides excellent visibility and can be autoclaved. The rims of the desiccator and lid are ground glass and require greasing before use to create an air-tight seal.

Also includes a perforated porcelain desiccator plate that fits onto a ridge above the lower chamber. A standard drying agent such as silica or anhydrous calcium chloride can be positioned in the lower chamber.

Item No.	Size	Flange OD/ID (mm)	Top Chamber Dia. / Height (mm)	Maximum Clearance* (mm)	Qty per pack
DSGL150	6" / 150mm	150/140	150/90	120	1
DSGL210	8" / 200mm	200/180	200/105	175	1
DSGL300	12" / 300mm	300 / 234	300 / 125	205	1

* Maximum clearance above plate.



Desiccators, Vacuum, Clear Base, PP/PC

These autoclavable desiccators are made of polypropylene (PP) and polycarbonate (PC) and can hold a vacuum up to 740mm Hg for 24 hours without any greasing. Autoclavable at 120°C for 15 minutes.

The top dome, molded in rigid and transparent PC, gives a crystal-clear view of the sample. The knurled knob on the top provides easy handling of the dome.

The transparent PC bottom provides increased viewing clarity. An internal groove on the flange holds the silicon rubber O-ring.

The PP stopcock has a self-lubricating PTFE plug. The three-way plug opens to create a vacuum, closes to hold a vacuum, and opens again to release a vacuum.

Item No.	Size	Flange OD/ID (mm)	Plate OD (mm)	Height (mm)	Maximum Clearance* (mm)	Qty per pack
55214	6" / 150mm	171/150	138	204	123	1
55215	8" / 200mm	232/199	190	257	166	1
55216	10" / 250mm	276/240	238	315	207	1
55217	12" / 300mm	340/300	295	405	255	1

* Maximum clearance above plate.



Evaporating Dishes, Flat Form, Porcelain

Shallow form with lip and flat bottom. Glazed except for rim and part of outside bottom. Autoclavable. Withstand temperatures to 1150°C. To prevent thermal stress cracks, we strongly recommend a heating/cooling rate not exceeding 200°C per hour. Excellent resistance to acids and alkalies except for hydrofluoric acid.

Item No.	Capacity (ml)	Top Outside Diameter (mm)	Quantity per pack
JEF035	35	65	6
JEF050	50	75	6
JEF080	80	85	6
JEF100	100	100	6
JEF200	200	120	6
JEF300	300	150	6



Evaporating Dishes, Round Form, Porcelain

Round form evaporating dishes include lip. Dishes from 35ml to 250ml capacity are glazed inside and outside. Dishes 385ml and larger are glazed inside and partially outside. Autoclavable. Withstand temperatures to 1150°C. To prevent thermal stress cracks, we strongly recommend a heating/cooling rate not exceeding 200°C per hour. Excellent resistance to acids and alkalies except for hydrofluoric acid.

Item No.	Capacity (ml)	Top Outside Diameter (mm)	Quantity per pack
JED035	35	60	6
JED070	70	75	6
JED080	80	80	6
JED120	120	94	6
JED150	150	100	6
JED250	250	115	6
JED385	385	145	1
JED525	525	162	1
JED765	765	185	1
JED1285	1285	215	1
JED2100	2100	265	1
JED3250	3250	305	1



Casseroles, Porcelain

With lip and flat porcelain handle. Glazed on inner and outer surfaces except for rim and top of handle. Autoclavable. Withstand temperatures to 1150°C. To prevent thermal stress cracks, we strongly recommend a heating/cooling rate not exceeding 200°C per hour. Excellent resistance to acids and alkalies except for hydrofluoric acid.

Item No.	Capacity (ml)	Height (mm)	Top Outside Diameter (mm)	Quantity per pack
JPC020	20	22	40	1
JPC060	60	33	70	1
JPC140	140	42	85	1
JPC200	200	52	100	1
JPC500	500	75	125	1
JPC750	750	88	150	1
JPC1200	1200	98	175	1



Combustion Boats, Porcelain

Glazed on inner and outer surfaces except for outside bottom surface.

Item No.	Capacity (ml)	L x W x H (mm)	Quantity per pack
JCB017	0.1	17 x 6 x 4	1
JCB060	2.0	60 x 10 x 8	1
JCB097	7.0	97 x 16 x 10	1
JCB100	12.0	100 x 20 x 13	1



Porcelain Casseroles, Economy

With lip and porcelain handle. Casseroles are glazed inside and out.

Item No.	Capacity (ml)	Height (mm)	Top Outside Diameter (mm)	Quantity per pack
PCS050	30	25	50	1
PCS070	80	35	70	1
PCS090	175	45	90	1
PCS100	220	50	100	1



Porcelain Evaporating Dishes, Economy

These glazed evaporating dishes can withstand temperatures up to 1050°C. Each dish is individually packed.

Item No.	Capacity (ml)	Top Outside Diameter (mm)	Quantity per pack
PED035	35	60	1
PED050	50	70	1
PED075	75	82	1
PED100	100	90	1
PED125	125	98	1



Petri Dishes, Polystyrene (PS)

Disposable polystyrene petri dishes offer optical clarity and strength at economical prices. 65mm dish includes a molded-in grid on the lid for easy colony counting. Sterilized.

Item No.	Dimensions (mm)	Quantity per pack	Quantity per case
K1006	65 diameter x 15 height	10	650
K1004-J	90 diameter x 15 height	10	500
K1001	150 diameter x 15 height	10	180
Petri Dish with Two Compartments			
K1003	90 diameter x 15 height, two compartment	10	500



Petri Dishes, Borosilicate Glass

Made from high quality borosilicate glass, these autoclavable, flat, clear petri dishes can withstand repeated sterilization and can be used many times. Each dish includes a lid. Note: lids do not seal air-tight.

Item No.	Description	Quantity per pack
G1060	Glass Petri Dish 60 x 65 x 15mm	10
G1075	Glass Petri Dish, 75 x 82 x 15mm	10
G1100	Glass Petri Dish, 100 x 107 x 20mm	10



Labware Dispensers



Bottle Top Dispensers

United brand bottle top dispensers offer high accuracy at economical prices. Each dispenser is individually calibrated and certified in an ISO 17025 accredited laboratory in accordance with ISO 8655 standards.

Five adapters are included with each unit for use with a wide range of bottle sizes. All wetted parts are made from PTFE and borosilicate glass for maximum chemical resistance.

These easy-to-use instruments are suitable for all laboratory applications except HF. Special precautions must be taken for use, cleaning, and storage when working with concentrated fuming acids.

A factory calibration certificate is provided with each bottle top dispenser. Dispensers are easy to disassemble and can be recalibrated in the lab. Fully autoclavable at 121°C, 15 psi for 10 to 15 minutes.

Item No.	Volume Range (ml)	Volume Increment (ml)	Accuracy (\pm % / ml)	CV (\pm % / ml)
BTDR-1	0.25 - 2.5	0.05	0.6 / 0.015	0.2 / 0.005
BTDR-2	0.5 - 5	0.1	0.5 / 0.025	0.1 / 0.005
BTDR-3	1 - 10	0.2	0.5 / 0.050	0.1 / 0.010
BTDR-4	2.5 - 30	0.5	0.5 / 0.150	0.1 / 0.030
BTDR-5	5 - 60	1.0	0.5 / 0.300	0.1 / 0.060
BTDR-6	10 - 100	2.0	0.6 / 0.600	0.2 / 0.200

Bottle Top Dispensers can be custom packaged as a set with glass or plastic bottles. Please call for details.

United bottle top dispensers are manufactured using carefully selected raw materials and go through several stages of strict quality checks during the manufacturing process.



Component	Description
Piston	PTFE
Cylinder	Glass
Volume Adjustment Knob	Valve Type
Valve Housing	PTFE
Valve Assembly	Glass Ball & Seat
Discharge Assembly	PTFE
Delivery Tube	FEP
Inlet Tube	FEP
Calibration	Individually calibrated and certified. In-lab easy calibration by the user is also possible.
Accuracy and Reproducibility	In accordance with ISO 8655 standards.
Compatibility	Excellent compatibility with all reagents except HF.



Volume Adjustment Knob: Quick-set volume adjustment knob with large pointer enables precise, easy, and fast volume adjustment.



Adjustable Nozzle with Cap: Delivery nozzle adjusts for easy dispensing at different angles. Cap prevents any unwanted drops on the workspace and avoids contact with chemicals.



Springless Valve: Specially designed, springless, PTFE valve manifold provides excellent chemical compatibility and leak-proof valve functioning.

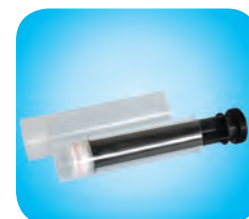

Glass Barrel Protection: Polypropylene sleeve protects glass barrel and prevents glass splitting in case of any accidental breakage.



An Individual Calibration certificate is provided with each Bottle Top Dispenser.



Scan to view demonstration video



Bottle Top Dispensers, Jade



Dispense a wide range of reagents with precision and accuracy using the Jade Bottle Top Dispenser. It features a re-circulation valve that redirects liquid back into the bottle without the loss of reagent. The Jade operates with a smooth plunger movement for bubble-free dispensing and effortless performance even under demanding laboratory conditions.

Fully Autoclavable at 121°C, 15psi. for 10 - 15 minutes.

Item No.	Volume Range (ml)	Volume Increment (ml)	Accuracy (± % / ml)	CV (± % / ml)
BTJD2.5	0.25 - 2.5	0.05	0.6 / 0.015	0.2 / 0.005
BTJD5	0.5 - 5	0.1	0.6 / 0.030	0.2 / 0.010
BTJD10	1 - 10	0.2	0.6 / 0.060	0.2 / 0.020
BTJD30	2.5 - 30	0.5	0.6 / 0.180	0.2 / 0.060
BTJD60	5 - 60	1.0	0.6 / 0.360	0.2 / 0.120
BTJD100	10 - 100	2.0	0.6 / 0.600	0.2 / 0.200

Bottle Top Dispensers, Sapphire



Save time and increase lab productivity using the Sapphire Bottle Top Dispenser. This convenient dispenser uses a dual valve technology that allows you to simply rinse and refill your bottle—without dismounting the dispenser!

Featuring functionality, user-friendliness and performance, the Sapphire Bottle Top Dispenser operates in four modes: Dilution, Rinsing, Dual Liquid Handling and Re-circulation.

Fully Autoclavable at 121°C, 15psi. for 10 - 15 minutes.



Scan to view demonstration video

Item No.	Volume Range (ml)	Volume Increment (ml)	Accuracy (± % / ml)	CV (± % / ml)
BTSR2.5	0.25 - 2.5	0.05	0.6 / 0.015	0.2 / 0.005
BTSR5	0.5 - 5	0.1	0.6 / 0.030	0.2 / 0.010
BTSR10	1 - 10	0.2	0.6 / 0.060	0.2 / 0.020
BTSR30	2.5 - 30	0.5	0.6 / 0.180	0.2 / 0.060
BTSR60	5 - 60	1.0	0.6 / 0.360	0.2 / 0.120
BTSR100	10 - 100	2.0	0.6 / 0.600	0.2 / 0.200



NEW PRODUCT

Winterization Labware Kits

Each convenient package includes a filtering flask, buchner funnel, filter adapter set, and medium flow filter paper. Filtering flasks are from our FG5340 series. They are constructed using heavy wall borosilicate and include a thick rim and hose barb. The 10,000ml set includes our FFB5340 series heavy wall borosilicate filtering bottle with hose barb. Porcelain buchner funnels are from our JBF series. All kits include our FASN07 filter adapter set. Filter paper is from our FPR series and has medium porosity and flow rate. Circular filters are packaged 100 per box.

WNTK2 2000ml Winterization Labware Kit Contents:

1. Filtering Flask, Borosilicate Glass, 2000ml (FG5340-2000)1
2. Buchner Funnel, Porcelain, 2000ml (JBF2000)1
3. Filter Adapter Set of 7, Synthetic Rubber (FASN07)1
4. Filter Paper, Medium Porosity/Flow, 18cm circle, pk/100 (FPR180)1

WNTK5 5000ml Winterization Labware Kit Contents:

1. Filtering Flask, Borosilicate Glass, 5000ml (FG5340-5000)1
2. Buchner Funnel, Porcelain, 4800ml (JBF4800)1
3. Filter Adapter Set of 7, Synthetic Rubber (FASN07)1
4. Filter Paper, Medium Porosity/Flow, 24cm circle, pk/100 (FPR240)1

WNTK10 10000ml Winterization Labware Kit Contents:

1. Filtering Bottle, Borosilicate Glass, 10000ml (FFB5340-10000)1
2. Buchner Funnel, Porcelain, 4800ml (JBF4800)1
3. Filter Adapter Set of 7, Synthetic Rubber (FASN07)1
4. Filter Paper, Medium Porosity/Flow, 24cm circle, pk/100 (FPR240)1

Item No.	Description
WNTK2	Winterization Labware Kit, 2000ml
WNTK5	Winterization Labware Kit, 5000ml
WNTK10	Winterization Labware Kit, 10000ml

NEW PRODUCT

Short Path Distillation Head

Short path Distillation Head with 24/40 flask joints and 10/30 thermometer port. Distillation head is manufactured from high quality 3.3 borosilicate glass and features a condenser coil and three 1/4" hose nozzles, two for condenser and one for vacuum.



Item No.	Description
DSH85	Short Path Distillation Head

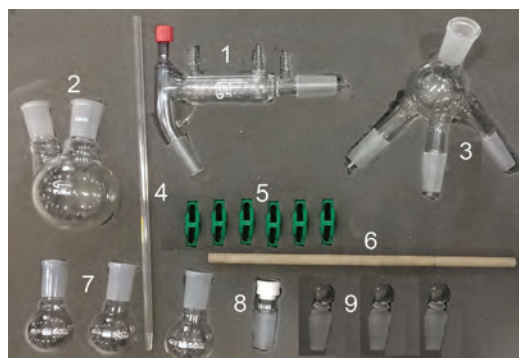

NEW PRODUCT

Short Path Distillation Kit, 250ml

This kit contains essential components for short path distillation. All glass parts are manufactured from high quality 3.3 borosilicate glass.

Short Path Distillation Head with 24/40 flask joints and 10/30 thermometer port features a condenser coil and three 1/4" hose nozzles, two for condenser and one for vacuum.

The cow-type Distillation Receiver has one 24/40 outer joint and three 24/40 inner joints that can be used to attach up to three (included) 50ml Single Neck round bottom flasks.

The 250ml round bottom 2-Neck flask includes 24/40 outer joints to accept the Distillation Head and the Rubber Inlet Adapter. The Rubber Inlet Adapter holds the tapered Glass Inlet Tube.

The Thermometer, with a range of -10° to 50° C and filled with a petroleum-based solution with red dye, connects to the Distillation Head through the 10/30 port.

Plastic Clamps (six included in the kit), size 24, are used to secure glassware connections.

Penny Head Glass Stoppers (three included in the kit) are used to cap the 50ml Single Neck round bottom flasks after distillate is collected.

Contents:

1. Short Path Distillation Head, Vacuum Jacketed, 24/401
2. Flask, Round Bottom, 2-Neck 250ml1
3. Distillation Receiver, Cow-Type, 1-to-3, 24/401
4. Glass Inlet Tube, with Tapered End, 11"1
5. Clamp for Jointed Glassware, Plastic, size 246
6. Thermometer, Red Spirit, -10° to 50° C, 12"1
7. Flask, Round Bottom, Single Neck, 50ml, 24/403
8. Inlet Adapter, Rubber, with Glass Connector, 24/401
9. Stopper, Glass, Penny Head, 24/403

Item No.	Description
SPDK01	Short Path Distillation Kit, 250ml



NEW PRODUCT

Short Path Distillation Kit, 10L

This kit contains essential components for short path distillation. All glass parts are manufactured from high quality 3.3 borosilicate glass.

Short Path Distillation Head (two included in the kit) with 24/40 flask joints features a condenser coil and three 1/4" hose nozzles, two for condenser and one for vacuum.

The cow-type Distillation Receiver (two included in the kit) has one 24/40 outer joint and three 24/40 inner joints that can be used to attach up to three 2000ml Single Neck round bottom evaporating flasks (six included in the kit).

The 10000ml round bottom 3-Neck flask includes 24/40 outer joints to accept the two included Distillation Heads. The center 24/40 joint holds the included Thermometer Inlet Adapter using a 10/30 port.

Penny Head Glass Stoppers (four included in the kit) are used to cap the 2000ml Single Neck round bottom flasks after distillate is collected.

PLEASE NOTE: Lab Jacks, Support Stands, Flask Stands, and Extension Clamps with Bosshead are not included in this kit.

Contents:

- 1. Short Path Distillation Head, Vacuum Jacketed, 24/40, 34/45 2
- 2. Flask, Round Bottom, 3-Neck 10000ml 24/40, 34/45 1
- 3. Distillation Receiver, Cow-Type, 250ml, 1-to-3, 24/40 2
- 4. Clamp for Jointed Glassware, Plastic, size 24 8
- 5. Clamp for Jointed Glassware, Plastic, size 34 2
- 6. Adapter Inlet, Thermometer, 24/40 1
- 7. Flask, Evaporating, Single Neck, 2000ml, 24/40 6
- 8. Stopper, Glass, Penny Head, 24/40 (not shown in photo) 4

Item No.	Description
SPD102	Short Path Distillation Kit, 10L



All-Glass Vacuum Filter Holder Set, 47mm



FHAG47

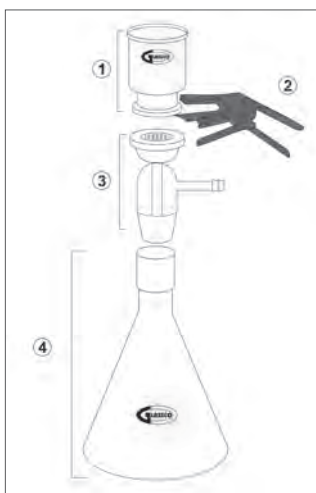

Replacement Parts

- 1 - FHGF300 Glass Funnel, 300ml
- 2 - FHSC47 Spring Clamp, 47mm
- 3 - FHGBC47 Glass Base and Cap, 47mm
- 4 - FHFG1000 Flask, 1000ml, with Ground Glass Joints

This all-glass filter holder is used in particulate contamination analysis for filtering aqueous, organic, or corrosive liquids. It is also recommended for HPLC solvent filtration. Complete set includes a borosilicate glass funnel, anodized aluminum spring clamp, vacuum base with sintered disc, and ground joint flask. Membrane filters are not included. Parts are also available separately.

Item No.	Description
FHAG47	Vacuum Filter Holder Set, 47mm
FHGF300	Replacement Glass Funnel, 300ml
FHSC47	Replacement Spring Clamp, 47mm
FHGBC47	Replacement Glass Base and Cap, 47mm
FHFG1000	Replacement Flask with Ground Glass Joints, 1000ml

Specifications

Materials:

Borosilicate glass funnel, base and tubulated cap; anodized aluminum spring clamp; fritted glass filter support

Filter Diameter:

47mm

Filtration Area:

9.6cm²

Capacity:

Funnel: 300ml
Flask: 1L

Outlet Fitting:

6mm (1/4") O.D. tubulated cap sidearm to vacuum

Vacuum Filter Holder Set with Fritted Glass Support Base, 47mm

Designed for bacteriological analysis of water using 47mm sterile membrane filters. Also applicable for analysis of suspended solids in water using 47mm depth filters. Complete set includes a borosilicate glass funnel and base, anodized aluminum spring clamp, and perforated silicone stopper. Parts are also available separately.

Item No.	Description
FHFT47	Vacuum Filter Holder Set, 47mm
FHGF300	Replacement Glass Funnel, 300ml
FHBG47	Replacement Base for 47mm Glass Filter Holder
FHSC47	Replacement Spring Clamp, 47mm
FHSTS8	Replacement Silicone Stopper, Perforated, Size #8

Specifications

Materials:

Borosilicate glass funnel and base; coarse-frit glass filter support; anodized aluminum spring clamp; silicone stopper

Filter Diameter:

47mm

Filtration Area:

9.6cm²

Capacity:

Funnel: 300ml

Prefilter Diameter:

Thick Depth Prefilter:

35mm

Membrane Prefilter: 47mm

Outlet Fitting:

6mm (1/4") O.D. tubulated cap sidearm to vacuum

Dimensions:

Height: 22.9cm

Diameter: 7.6cm

Sterilization Method:

30 UV sterilize or autoclave without filter in place

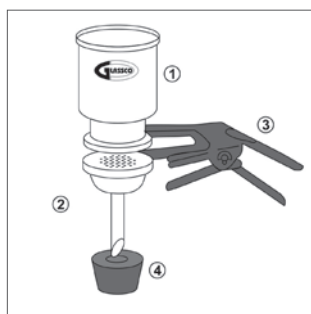

Replacement Parts

- 1 - FHGF300 Glass Funnel, 300ml
- 2 - FHBG47 Base for 47mm Glass Filter Holder
- 3 - FHSC47 Spring Clamp, 47mm
- 4 - FHSTS8 Silicone Stopper, Perforated, Size #8



FHFT47

Optional Accessories

Item No.	Description
FHFL1000	Vacuum Filtering Flask, 1L capacity
FHFL4000	Vacuum Filtering Flask, 4L capacity



Vacuum Filter Holder Set with PTFE Coated Funnel and Base, 47mm

Designed for bacteriological analysis where it is necessary to sterilize the filter holder with the membrane filter in place. The glass surface is coated with PTFE to avoid filter damage and membrane adhesion during autoclaving. Complete set includes a PTFE-faced borosilicate glass funnel and PTFE-faced base, anodized aluminum spring clamp, and perforated aluminum spring clamp, and perforated silicone stopper. Parts are also available separately.

Item No.	Description
FHPT47	Vacuum Filter Holder Set with PTFE-Coated Funnel and Base, 47mm
FHFP300	Replacement PTFE-Coated Glass Funnel, 300ml
FHBP47	Replacement PTFE-Coated Glass Base, 47mm
FHSC47	Replacement Spring Clamp, 47mm
FHSTS8	Replacement Silicone Stopper, Perforated, Size #8

Specifications

Materials:

Borosilicate PTFE-faced glass funnel and PTFE-faced base; anodized aluminum spring clamp; silicone stopper

Filter Diameter:

47mm

Filtration Area:

9.6cm²

Capacity:

Funnel: 300ml

Prefilter Diameter:

Thick Depth Prefilter:

35mm

Membrane Prefilter: 47mm

Outlet Fitting:

6mm (1/4") O.D. tubulated cap sidearm to vacuum

Dimensions:

Height: 22.9cm

Diameter: 7.6cm

Sterilization Method:

30 UV sterilize or autoclave without filter in place

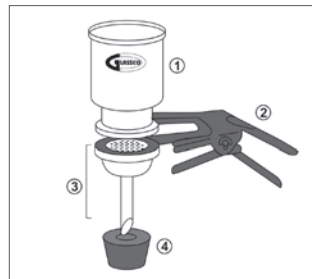

Replacement Parts

- 1 - FHFP300 PTFE-Coated Glass Funnel, 300ml
- 2 - FHSC47 Spring Clamp, 47mm
- 3 - FHBP47 PTFE-Coated Glass Base, 47mm
- 4 - FHSTS8 Silicone Stopper, Perforated, Size #8



FHPT47

Optional Accessories

Item No.	Description
FHFL1000	Vacuum Filtering Flask, 1L capacity
FHFL4000	Vacuum Filtering Flask, 4L capacity

Vacuum Filter Holder Set with Stainless Steel Screen, 47mm

Designed for analyzing particulate contamination of hydraulic fluids and oils using gravimetric or particulate counting methods, and can be used in exfoliative cytology applications. Complete set includes a borosilicate glass funnel and base, anodized aluminum spring clamp, stainless steel support screen, PTFE gasket, and perforated silicone stopper. Parts are also available separately.



FHSS47

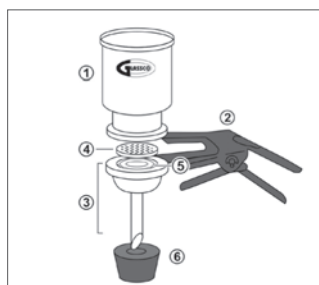

Replacement Parts

- 1 - FHGF300 Glass Funnel, 300ml
- 2 - FHSC47 Spring Clamp, 47mm
- 3 - FHBS47 Glass Base, 47mm
- 4 - FHSSR47 Support Screen, Stainless, 47mm
- 5 - FHGSP47 Gasket, PTFE, 47mm
- 6 - FHSTS8 Silicone Stopper, Perforated, Size #8

Item No.	Description
FHSS47	Vacuum Filter Holder Set with Stainless Steel Screen, 47mm
FHGF300	Replacement Glass Funnel, 300ml
FHBS47	Replacement Glass Base, 47mm
FHSC47	Replacement Spring Clamp, 47mm
FHSSR47	Replacement Support Screen, Stainless, 47mm
FHGSP47	Replacement Gasket, PTFE, 47mm
FHSTS8	Replacement Silicone Stopper, Perforated, Size #8

Specifications

Materials:

Borosilicate glass funnel and base; stainless steel screen filter support; anodized aluminum spring clamp; silicone stopper

Filter Diameter:

47mm

Filtration Area:

9.6cm²

Capacity:

Funnel: 300ml

Prefilter Diameter:

Thick Depth Prefilter:

35mm

Membrane Prefilter: 47mm

Outlet Fitting:

6mm (1/4") O.D. tubulated cap sidearm to vacuum

Dimensions:

Height: 22.9cm

Diameter: 7.6cm

Sterilization Method:

30 UV sterilize or autoclave without filter in place

Optional Accessories

Item No.	Description
FHFL1000	Vacuum Filtering Flask, 1L capacity
FHFL4000	Vacuum Filtering Flask, 4L capacity



Microanalysis Vacuum Filter Holder Set, 25mm with Fritted Glass Filter Support



FHMA25

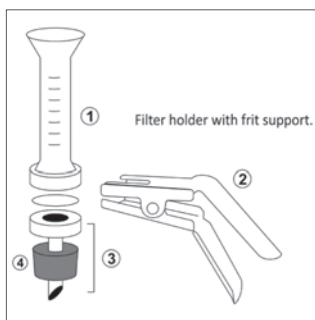

Replacement Parts

- 1 - FHGF15 Glass Funnel, 15ml
- 2 - FHSC25 Spring Clamp, 25mm
- 3 - FHGBS25 Fritted Glass Base with Stopper, 25mm
- 4 - FHSTS5 Silicone Stopper, No. 5

Designed for particulate or biological contamination analysis of small volumes using a vacuum filter. Includes a fritted glass filter support and No. 5 perforated silicone stopper for easy attachment to a vacuum filtering flask. Membrane filters are not included. Thick prefilters or laminated filters will not seal in this holder, and it is not autoclavable with membrane filters installed. Unlaminated PTFE or PVDF membranes are recommended for solvent applications.

Complete set includes a borosilicate glass funnel and base, fritted glass filter support, anodized aluminum spring clamp, and silicone stopper. Parts are also available separately.

Item No.	Description
FHMA25	Microanalysis Vacuum Filter Holder Set, Fritted Glass, 25mm
FHGF15	Replacement Glass Funnel, 15ml
FHSC25	Replacement Spring Clamp, 25mm
FHGBS25	Replacement Fritted Glass Base with Stopper, 25mm
FHSTS5	Replacement Perforated Silicone Stopper, No. 5

Optional Accessory

Item No.	Description
FHFL125	Vacuum Filtering Flask, 125ml capacity

Specifications

Materials:

Borosilicate glass funnel and base; anodized aluminum spring clamp; fritted glass filter support; silicone stopper

Filter Diameter:

25mm

Filtration Area:

2.5cm²

Capacity:

Funnel: 15ml

Outlet Fitting:

No. 5 perforated silicone stopper mounts in standard 125ml filtering flask

Dimensions:

Height: 15.2cm
Diameter: 2.5cm

Microanalysis Vacuum Filter Holder Set, 25mm with Stainless Filter Support

Designed for particulate or biological contamination analysis of small volumes using a vacuum filter. Includes a stainless steel screen filter support and No. 5 perforated silicone stopper for easy attachment to a vacuum filtering flask. Membrane filters are not included. Thick prefilters or laminated filters will not seal in this holder, and it is not autoclavable with membrane filters installed. Unlaminated PTFE or PVDF membranes are recommended for solvent applications.

Complete set includes a borosilicate glass funnel and base, removable stainless steel screen filter support, anodized aluminum spring clamp, and silicone stopper. Parts are also available separately.



FHMA25-S

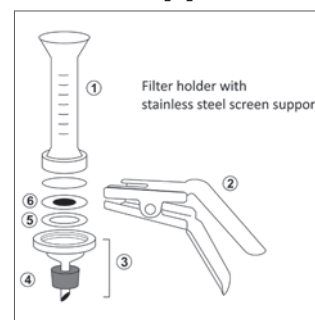

Replacement Parts

- 1 - FHGF15 Glass Funnel, 15ml
- 2 - FHSC25 Spring Clamp, 25mm
- 3 - FHBSS25 Base and Stainless Steel Screen, 25mm
- 4 - FHSTS5 Silicone Stopper, No. 5
- 5 - FHGSTF Teflon Gasket
- 6 - FHSSR25 Support Screen, Stainless Steel, 25mm

Specifications

Materials:

Borosilicate glass funnel and base; anodized aluminum spring clamp; removable stainless steel screen filter support; silicone stopper

Filter Diameter:

25mm

Filtration Area:

2.5cm²

Capacity:

Funnel: 15ml

Outlet Fitting:

No. 5 perforated silicone stopper mounts in standard 125ml filtering flask

Dimensions:

Height: 15.2cm
Diameter: 2.5cm

Optional Accessory

Item No.	Description
FHFL125	Vacuum Filtering Flask, 125ml capacity



All-Glass Vacuum Filter Holder Set, 90mm

This all-glass filter holder is used in particulate contamination analysis for filtering aqueous, organic, or corrosive liquids. It is also recommended for HPLC solvent filtration. Complete set includes a borosilicate glass funnel, base and tubulated cap, anodized aluminum spring clamp, and PTFE-coated stainless steel screen. Membrane filters are not included. Parts are also available separately.

Item No.	Description
FHSS90	Vacuum Filter Holder Set, 90mm
FHGF1000	Replacement Glass Funnel, 1000ml
FHSC90	Replacement Spring Clamp, 90mm
FHGBC90	Replacement Glass Base and Cap, 90mm
FHSSR90	Replacement Support Screen, Stainless, PTFE Coated, 90mm
FHGSP90	Replacement Gasket, PTFE, 90mm



FHBT2000



FHFG1000



FHSS90

Optional Accessories

Item No.	Description
FHFG1000	Flask, 1000ml capacity, with Ground Glass Joints
FHBT2000	Vacuum Bottle, 2L capacity
FHBT5000	Vacuum Bottle, 5L capacity

Specifications

Materials:

Borosilicate glass funnel, base and tubulated cap; anodized aluminum spring clamp; PTFE-coated stainless steel screen

Filter Diameter:

90mm

Capacity:

Funnel: 1000ml

Outlet Fitting:

6mm (1/4") O.D. tubulated cap sidearm to vacuum

Plastic Clamps for Jointed Glassware

Plastic conical joint clips are size 24, designed to securely hold 24/40 joint size glassware together.



Item No.	Description
CLJP24	Plastic Clamp for Jointed Glassware
CLJP24-PK/10	Plastic Clamp for Jointed Glassware, pack of 10

Filter Papers, Circular, Grade 1

The most widely used qualitative filter paper for routine applications. Medium porosity and flow rate. 100 circles packed in a cardboard box.



Item No.	Diameter (cm)	Quantity per pack
FPR007	7	100
FPR009	9	100
FPR011	11	100
FPR125	12.5	100
FPR150	15	100
FPR180	18	100
FPR240	24	100
FPR320	32	100



Scan to view demonstration video

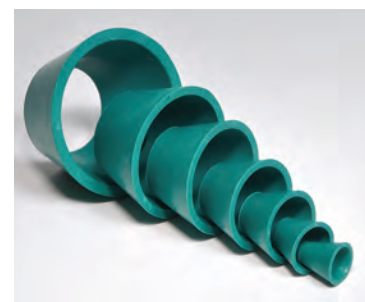

Filter Adapter Set of 7, Synthetic Rubber

Set of seven synthetic rubber adapter cones designed to fit Buchner and fritted glass funnels, porcelain filters without headpieces, and for reverse flow cleaning of filter crucibles. Adapters can be used to support funnels, Gooch crucibles, filter tubes, and other apparatus in filtration assemblies. These adapters are functional even if not tightly fitted around the funnel stem. Can be used individually or nested with adjacent sizes. Provide an excellent alternative to boring special size holes in rubber stoppers. Autoclavable.

Item No.	Description
FASN07	Filter Adapter Set of 7, Synthetic Rubber

Adapter #	Top OD (mm)	Bottom OD (mm)	Top ID (mm)	Bottom ID (mm)
1	21	10	17	6
2	27	16	20	10
3	36	21	30	15
4	45	27	39	21
5	57	37	50	29
6	70	45	62	35
7	90	55	80	46

Filter Papers, Rectangular, Grade 1

The most widely used qualitative filter paper for routine applications. Medium porosity and flow rate.



Item No.	Dimensions (inches)	Quantity per pack
FPR8X11	8.5" x 11"	100
FPR18X22	18" x 22"	100

Rubber Filter Aid

This molded rubber filter disc is designed to support and seal a filter crucible or a funnel in the neck of a filter flask. Inside diameter of the socket at top is 32mm, and outside diameter of the disc is 76mm. The bottom of the disc is flat so that it seals tightly against the lip of the flask.



Item No.	Description
FLTR01	Rubber Filter Aid



Boiling Flasks, Round Bottom, Ground Glass Joints, Borosilicate Glass

Our boiling flasks with ground glass joints are made from low-expansion borosilicate glass. Feature uniform wall thickness for superior mechanical strength and shock resistance.

Item No.	Capacity (ml)	Approx. O.D. x Height (mm)	Joint Size	Qty per pack	Qty per case
FRB057-50	50	51 x 100	24/40	6	24
FRB057-100	100	64 x 118	24/40	6	24
FRB057-250	250	85 x 140	24/40	6	24
FRB057-500	500	105 x 158	24/40	6	24
FRB057-1000	1000	130 x 185	24/40	6	24
FRB057-2000	2000	165 x 215	24/40	1	6
FRB057-3000	3000	185 x 250	24/40	1	1
FRB057-5000	5000	223 x 305	24/40	1	1



Boiling Flasks, Flat Bottom, Ground Glass Joints, Borosilicate Glass

Our boiling flasks with ground glass joints are made from low-expansion borosilicate glass. Feature uniform wall thickness for superior mechanical strength and shock resistance.

Item No.	Capacity (ml)	Approx. O.D. x Height (mm)	Joint Size	Qty per pack	Qty per case
FFB058-50	50	51 x 100	24/40	6	24
FFB058-100	100	64 x 118	24/40	6	24
FFB058-250	250	85 x 130	24/40	6	24
FFB058-500	500	105 x 162	24/40	6	24
FFB058-1000	1000	132 x 178	24/40	6	24
FFB058-2000	2000	165 x 205	24/40	1	6
FFB058-3000	3000	185 x 240	24/40	1	1
FFB058-5000	5000	223 x 290	24/40	1	1



FSC100



FSC120

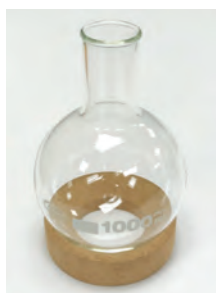

FSC120 shown with 1000ml Round Bottom Flask

NEW PRODUCT

Flask Stands, Cork

Made of fine particle compressed cork, these rings are designed to support round bottom flasks, beakers, dishes and more. Cork is naturally elastic with very low thermal and electrical conductivity properties.

Small cork stand has a diameter of 100mm and holds 250ml to 2000ml round bottom flasks. Large cork stand has a diameter of 120mm and holds 500ml to 3000ml round bottom flasks.

Item No.	Description
FSC100	Flask Stand, Cork, 100mm diameter
FSC120	Flask Stand, Cork, 120mm diameter



Flask Stand, PP

For use with flasks up to 10L, this polypropylene stand is ribbed to safely hold flasks in place. Autoclavable.

Item No.	Description	Quantity per pack
45105	Flask Stand, PP	1

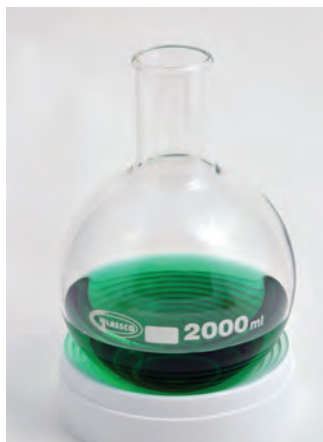

FG4260 series
Boiling Flasks also available in 5, 6, 10 and 20L capacities. Call for details.



FG4060 series
Boiling Flasks also available in 6, 10 and 20L capacities. Call for details.

Boiling Flasks, Round Bottom, Borosilicate Glass

Our boiling flasks are made from low-expansion borosilicate glass. Feature uniform wall thickness for superior mechanical strength and shock resistance.

Item No.	Capacity (ml)	Approx. O.D. x Height (mm)	Quantity per pack	Quantity per case
FG4260-25	25	42 x 90	6	24
FG4260-50	50	51 x 95	6	24
FG4260-100	100	64 x 110	6	24
FG4260-125*	125	69 x 115	6	24
FG4260-150*	150	74 x 118	6	24
FG4260-250	250	85 x 145	6	24
FG4260-300*	300	88 x 148	6	24
FG4260-500	500	105 x 168	6	24
FG4260-1000	1000	131 x 200	6	24
FG4260-2000	2000	166 x 240	1	6
FG4260-3000	3000	185 x 260	1	1



Distilling Flasks, Borosilicate Glass

Our distilling flasks are made from low-expansion borosilicate glass. Uniform wall thickness provides superior mechanical strength and shock resistance. Long side arm is ideal for distillation applications. Feature large white block letters for easy identification of capacity.

Item No.	Capacity (ml)	Quantity per pack
FG4620-100	100	12
FG4620-125	125	12
FG4620-250	250	12
FG4620-500	500	6
FG4620-1000	1000	6
FG4620-2000	2000	4

Boiling Flasks, Flat Bottom, Borosilicate Glass

Our boiling flasks are made from low-expansion borosilicate glass. Feature uniform wall thickness for superior mechanical strength and shock resistance.

Item No.	Capacity (ml)	Approx. O.D. x Height (mm)	Quantity per pack	Quantity per case
FG4060-50	50	51 x 90	6	24
FG4060-100	100	64 x 105	6	24
FG4060-150	150	74 x 112	6	24
FG4060-250	250	85 x 138	6	24
FG4060-300	300	88 x 143	6	24
FG4060-500	500	105 x 163	6	24
FG4060-1000	1000	131 x 190	1	6
FG4060-2000	2000	166 x 230	1	6
FG4060-3000	3000	185 x 250	1	1
FG4060-5000	5000	223 x 290	1	1



Recovery Flasks, Pear Shaped, Borosilicate Glass

Heavy wall recovery flasks are ideal for use with rotary evaporators. Flasks feature a square bead and a single neck with ground glass 24/40 joint. Opening at top is designed for easy recovery of reaction products using a spatula. Flask bottom fits standard heating mantles.

Recovery flasks can be special ordered with custom joint sizes and capacities.

Item No.	Capacity (ml)	Approx. O.D. x Height (mm)	Joint Size	Qty per pack	Qty per case
FGR0050	50	48 x 85	24/40	6	24
FGR0100	100	60 x 105	24/40	6	24
FGR0250	250	80 x 140	24/40	6	24
FGR0500	500	100 x 175	24/40	6	24
FGR1000	1000	120 x 210	24/40	6	24
FGR2000	2000	160 x 250	24/40	1	8



Erlenmeyer Flasks, Narrow Mouth, Borosilicate Glass

Borosilicate glass flasks are designed to give the best combination of thermal shock resistance and physical strength. Feature heavy-duty rims and graduations in durable white enamel.

Item No.	Capacity (ml)	Graduation Range (ml)	Graduation Interval (ml)	Qty per pack	Qty per case
FG4980-10*	10	NA	NA	12	36
FG4980-25	25	10 - 25	5	12	48
FG4980-50	50	20 - 50	10	12	48
FG4980-100	100	50 - 100	25	12	48
FG4980-125	125	50 - 125	25	12	48
FG4980-150	150	75 - 150	25	6	24
FG4980-250	250	50 - 200	25	12	48
FG4980-500	500	100 - 500	50	6	36
FG4980-1000	1000	250 - 1000	50	6	24
FG4980-2000	2000	600 - 2000	200	1	8
FG4980-3000	3000	1000 - 3000	500	1	1
FG4980-5000	5000	1500 - 5000	500	1	1

* Note: 10ml flask is not graduated.



Scan to view demonstration video

Erlenmeyer Flask Set of 5, Borosilicate Glass

A convenient set of five of our narrow mouth borosilicate glass Erlenmeyer flasks. Set consists of one each of 50ml, 125ml, 250ml, 500ml, and 1000ml flasks.

Borosilicate glass flasks are designed to give the best combination of thermal shock resistance and physical strength. Feature heavy-duty rims and graduations in durable white enamel.

Item No.	Description
FGSET5	Erlenmeyer Flask Set of 5, Borosilicate Glass

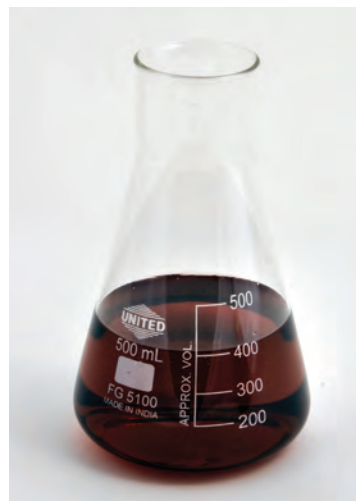

Erlenmeyer Flasks, Wide Mouth, Borosilicate Glass

Wide mouth flasks are ideal for titrations and culture work. Borosilicate glass flasks are designed to give the best combination of thermal shock resistance and physical strength. Feature heavy-duty rims and graduations in durable white enamel.

Item No.	Capacity (ml)	Approx. O.D. x Height (mm)	Quantity per pack	Quantity per case
FG5100-100	100	70 x 110	12	48
FG5100-125	125	69 x 117	12	48
FG5100-250	250	84 x 138	12	48
FG5100-500	500	105 x 186	6	36
FG5100-1000	1000	131 x 222	6	24

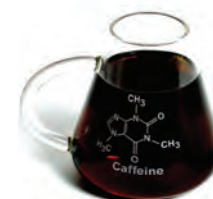

Back of flask shows the molecular structure of caffeine.

Flask Mug, Borosilicate Glass

This 500ml borosilicate glass flask features an attached handle and a smooth rim. The molecular structure of caffeine is enameled in white on one side, and the other side has standard flask graduations.

Item No.	Description
FGMG500	Flask Mug, Borosilicate, 500ml

Flask mugs can be private labeled. Please call for details.



Erlenmeyer Flasks, with Screw Cap, Borosilicate Glass

Recommended for culturing, mixing and storing applications. Borosilicate glass flasks are designed to give the best combination of thermal shock resistance and physical strength. Feature heavy-duty rims and graduations in durable white enamel. Blue screw caps with liner are autoclavable.



Item No.	Capacity (ml)	Approx. O.D. x Height (mm)	Quantity per pack	Quantity per case
FG5021-100	100	64 x 100	6	24
FG5021-150	150	72 x 118	6	24
FG5021-250	250	85 x 140	6	24
FG5021-500	500	104 x 175	6	24
FG5021-1000	1000	131 x 220	1	4

Filtering Flasks, Borosilicate Glass

Heavy wall borosilicate filtering flask includes a heavy-duty rim and a bolt neck with tubulation. Graduations are printed in durable white enamel.

Item No.	Capacity (ml)	Approx. O.D. x Height (mm)	Quantity per pack	Quantity per case
FG5340-50	50	52 x 85	6	24
FG5340-100	100	64 x 108	6	24
FG5340-250	250	86 x 160	1	18
FG5340-500	500	108 x 190	1	18
FG5340-1000	1000	138 x 245	1	12
FG5340-2000	2000	170 x 305	1	12
FG5340-5000	5000	237 x 390	1	1

Erlenmeyer Flasks, Wide Mouth, PP

Wide mouth polypropylene flasks are autoclavable and include a screw cap for easy mixing and storage of solutions. Flasks are graduated to show approximate volumes.



Item No.	Capacity (ml)	Graduation Interval (ml)	Quantity per pack
FP0125	125	25	12
FP0250	250	50	12
FP0500	500	50	12



NEW PRODUCT

Filtering Bottles, Borosilicate Glass

With thick glass walls and sturdy construction, these bottles/flasks are perfect for filtering large volumes of liquid. The thick walls and design enable these flasks to withstand vacuum filtration without imploding. Accuracy of +/- 5%. Neck size fits a #13 rubber stopper. The hose barb has an O.D. of 1/2".

Item No.	Capacity (ml)	Grad. Range (ml)	Grad. Interval (ml)	Quantity per pack	Quantity per case
FFB5340-10000	10000	2000-8000	1000	1	1
FFB5340-20000	20000	4000-16000	2000	1	1



Flask Tongs, Stainless Steel

Stainless steel flask tongs are 12" long with riveted joints. Heavy duty construction safely accommodates flasks up to 5000ml. Silicone-coated jaws grip flasks firmly and open to 6".

Item No.	Description
FTSS04	Flask Tongs, Stainless Steel



Volumetric Flasks, Class A, with Glass Stopper, Individually Certified

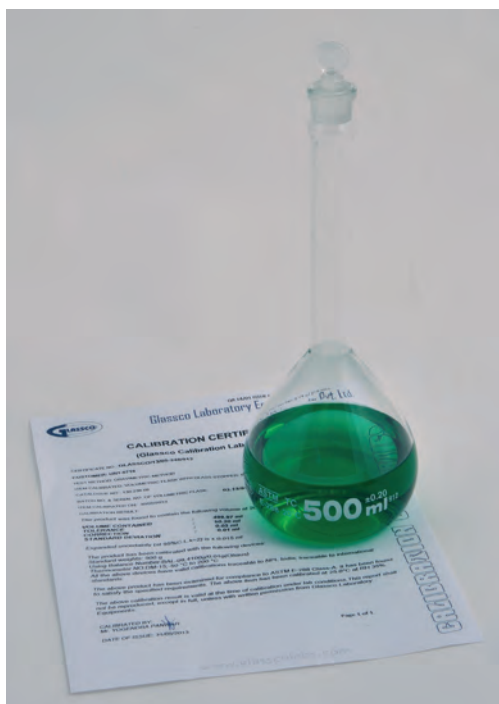

Durable, machine-blown body. Heavy beaded tubing neck. Flasks feature a sharp graduation line and large white block letters. A ground glass stopper is included. Meets Class A specifications per ASTM E288. Individually serialized and certified.

Item No.	Capacity (ml)	Tolerance (\pm ml)	Stopper Size	Quantity per pack
FG5639-5	5	0.02	9	1
FG5639-10	10	0.02	9	1
FG5639-20	20	0.03	9	1
FG5639-25	25	0.03	9	1
FG5639-50	50	0.05	9	1
FG5639-100	100	0.08	13	1
FG5639-200	200	0.10	16	1
FG5639-250	250	0.12	16	1
FG5639-500	500	0.20	19	1
FG5639-1000	1000	0.30	22	1
FG5639-2000	2000	0.50	27	1

Volumetric Flasks, Class A, with Glass Stopper, Batch Certified

Durable, machine-blown body. Heavy beaded tubing neck. Flasks feature a sharp graduation line and large white block letters. A ground glass stopper is included. Meets Class A specifications per ASTM E288. Batch certified.

Item No.	Capacity (ml)	Tolerance (\pm ml)	Stopper Size	Quantity per pack
FG5640-5	5	0.02	9	1
FG5640-10	10	0.02	9	1
FG5640-20	20	0.03	9	1
FG5640-25	25	0.03	9	1
FG5640-50	50	0.05	9	1
FG5640-100	100	0.08	13	1
FG5640-200	200	0.10	16	1
FG5640-250	250	0.12	16	1
FG5640-500	500	0.20	19	1
FG5640-1000	1000	0.30	22	1
FG5640-2000	2000	0.50	27	1





Volumetric Flasks, Class A, with Snap Cap, Batch Certified

Durable, machine-blown body. Heavy beaded tubing neck. Flasks feature a sharp graduation line and large white block letters. A plastic snap cap is included. Meets Class A specifications per ASTM E288. Batch certified.

Item No.	Capacity (ml)	Tolerance (\pm ml)	Plastic Cap Number	Quantity per pack
FG5580-50	50	0.05	3	1
FG5580-100	100	0.08	4	1
FG5580-200	200	0.10	5	1
FG5580-250	250	0.12	5	1
FG5580-500	500	0.20	5	1
FG5580-1000	1000	0.30	6	1
FG5580-2000	2000	0.50	8	1

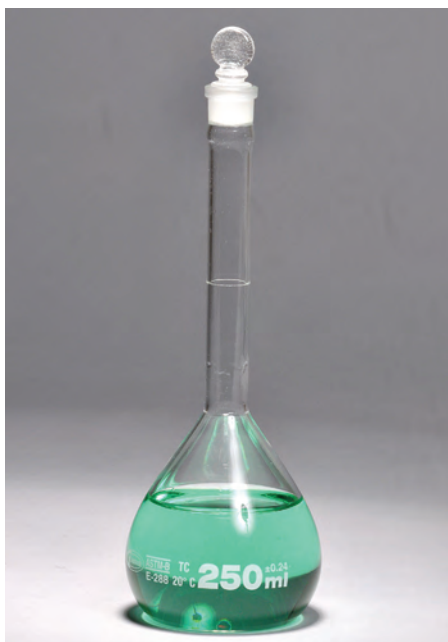

Volumetric Flasks, Class B, with Glass Stopper

Durable, machine-blown body. Heavy beaded tubing neck. Flasks feature a sharp graduation line and large white block letters. A ground glass stopper is included.

Item No.	Capacity (ml)	Tolerance (\pm ml)	Stopper Size	Quantity per pack
FG5641-5	5	0.04	9	12
FG5641-10	10	0.04	9	12
FG5641-25	25	0.06	9	12
FG5641-50	50	0.10	9	12
FG5641-100	100	0.16	13	12
FG5641-200	200	0.20	16	12
FG5641-250	250	0.24	16	12
FG5641-500	500	0.40	19	12
FG5641-1000	1000	0.60	22	6
FG5641-2000	2000	1.00	27	4

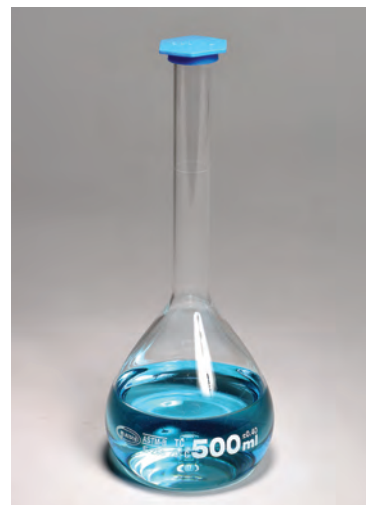

Volumetric Flasks, Class B, with Snap Cap

Durable, machine-blown body. Heavy beaded tubing neck. Flasks feature a sharp graduation line and large white block letters. A plastic snap cap is included.

Item No.	Capacity (ml)	Tolerance (\pm ml)	Plastic Cap Number	Quantity per pack
FG5581-50	50	0.10	3	12
FG5581-100	100	0.16	4	12
FG5581-250	250	0.24	5	12
FG5581-500	500	0.40	5	12
FG5581-1000	1000	0.60	6	6
FG5581-2000	2000	1.0	8	4



Labware Flasks



Volumetric Flasks, Class A, with Glass Stopper, Batch Certified, QR

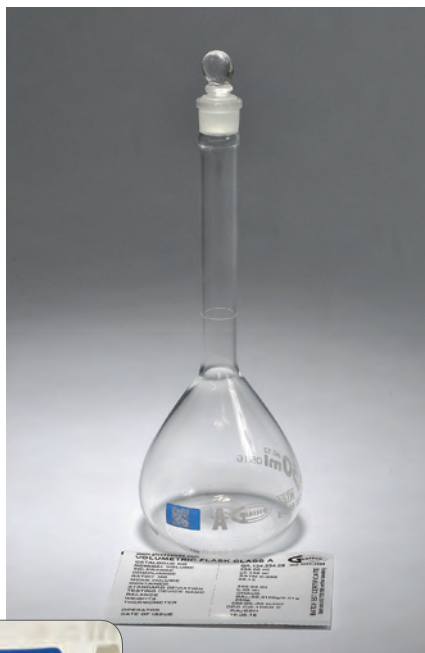

Each flask includes a QR code that can be scanned to quickly obtain a copy of the certificate of calibration, certificate of conformity, and user manual.

Durable, machine-blown body. Heavy beaded tubing neck. Flasks feature a sharp graduation line and large white block letters. A ground glass stopper is included. Meets Class A specifications per ASTM E288. Batch certified.

Our volumetric flasks feature QR code integration to facilitate quick and easy access to certificates of calibration, certificates of conformity, and user manuals where applicable. This is first of its kind innovative technology only available on United glassware. We recommend the NeoReader app for scanning QR codes. Simply point your smartphone to the QR code printed on the flask. Enter the serial number when prompted, and the app automatically takes you to the certificate screen.

Item No.	Capacity (ml)	Tolerance (\pm ml)	Stopper Size	Quantity per pack
FG5640-5QR	5	0.02	9	1
FG5640-10QR	10	0.02	9	1
FG5640-20QR	20	0.03	9	1
FG5640-25QR	25	0.03	9	1
FG5640-50QR	50	0.05	9	1
FG5640-100QR	100	0.08	13	1
FG5640-200QR	200	0.10	16	1
FG5640-250QR	250	0.12	16	1
FG5640-500QR	500	0.20	19	1
FG5640-1000QR	1000	0.30	22	1
FG5640-2000QR	2000	0.50	27	1

Volumetric Flasks, Class A, with Glass Stopper, Individually Certified, QR

Durable, machine-blown body. Heavy beaded tubing neck. Flasks feature a sharp graduation line and large white block letters. A ground glass stopper is included. Meets Class A specifications per ASTM E288. Individually serialized and certified.

Our volumetric flasks feature QR code integration to facilitate quick and easy access to certificates of calibration, certificates of conformity, and user manuals where applicable. This is first of its kind innovative technology only available on United glassware. We recommend the NeoReader app for scanning QR codes. Simply point your smartphone to the QR code printed on the flask. Enter the serial number when prompted, and the app automatically takes you to the certificate screen.

Item No.	Capacity (ml)	Tolerance (\pm ml)	Stopper Size	Quantity per pack
FG5639-5QR	5	0.02	9	1
FG5639-10QR	10	0.02	9	1
FG5639-20QR	20	0.03	9	1
FG5639-25QR	25	0.03	9	1
FG5639-50QR	50	0.05	9	1
FG5639-100QR	100	0.08	13	1
FG5639-200QR	200	0.10	16	1
FG5639-250QR	250	0.12	16	1
FG5639-500QR	500	0.20	19	1
FG5639-1000QR	1000	0.30	22	1
FG5639-2000QR	2000	0.50	27	1

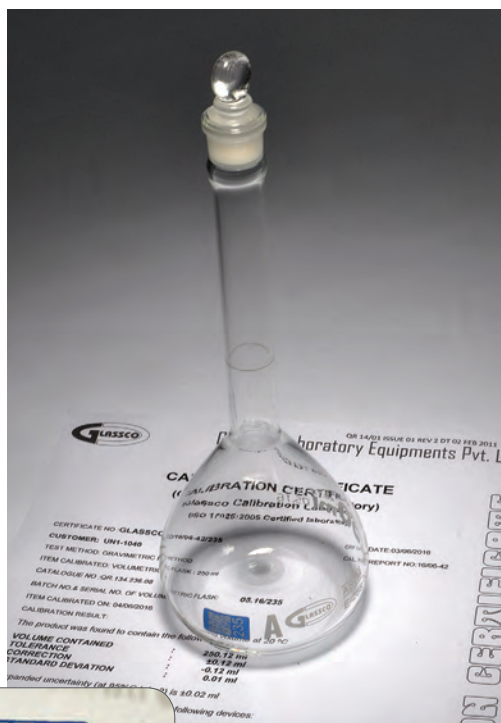

Each flask includes a QR code that can be scanned to quickly obtain a copy of the certificate of calibration, certificate of conformity, and user manual.



Volumetric Flasks, Class A, with Snap Cap, Batch Certified, QR

Durable, machine-blown body. Heavy beaded tubing neck. Flasks feature a sharp graduation line and large white block letters. A plastic snap cap is included. Meets Class A specifications per ASTM E288. Batch certified.

Our volumetric flasks feature QR code integration to facilitate quick and easy access to certificates of calibration, certificates of conformity, and user manuals where applicable. This is first of its kind innovative technology only available on United glassware. We recommend the NeoReader app for scanning QR codes. Simply point your smartphone to the QR code printed on the flask. Enter the serial number when prompted, and the app automatically takes you to the certificate screen.

Item No.	Capacity (ml)	Tolerance (\pm ml)	Plastic Cap Number	Quantity per pack
FG5580-50QR	50	0.05	3	1
FG5580-100QR	100	0.08	4	1
FG5580-200QR	200	0.10	5	1
FG5580-250QR	250	0.12	5	1
FG5580-500QR	500	0.20	5	1
FG5580-1000QR	1000	0.30	6	1
FG5580-2000QR	2000	0.50	8	1

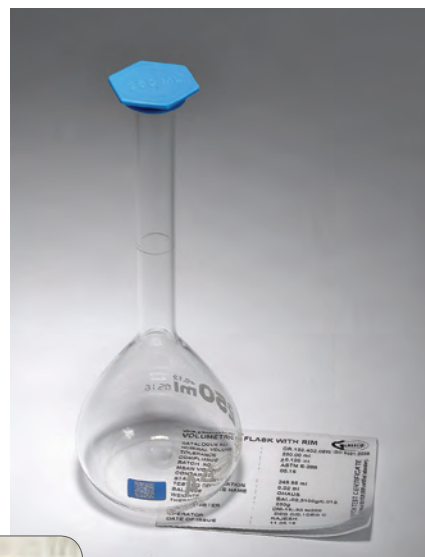

Each flask includes a QR code that can be scanned to quickly obtain a copy of the certificate of calibration, certificate of conformity, and user manual.



Scan to view demonstration video

Volumetric Flasks, Class A, Individually Certified, Wide Mouth, Amber Glass, QR

Amber-colored borosilicate glass volumetric flasks are manufactured as per ASTM E288 Class A serialized glassware specifications. Calibrated to contain (TC), these flasks feature white enamel printing and diamond etched graduation line.

Our flasks feature heavy-duty and uniform wall thickness, and a wide mouth design for easy pipette access. Amber color protects light sensitive materials.

Each unit comes with a printed calibration certificate, as well as with a printed QR code for easy access to the calibration certificate any time / anywhere, using your mobile device or computer.



Each flask includes a QR code that can be scanned to quickly obtain a copy of the certificate of calibration, certificate of conformity, and user manual.

Item No.	Capacity (ml)	Tolerance (\pm ml)	Stopper Size	Quantity per pack
FGAM005	5	0.02	13	1
FGAM010	10	0.02	13	1
FGAM020	20	0.03	13	1
FGAM025	25	0.03	13	1
FGAM050	50	0.05	13	1
FGAM100	100	0.08	16	1
FGAM200	200	0.10	19	1
FGAM250	250	0.12	19	1



Forceps, Stainless Steel



Good quality stainless steel forceps for general use in the laboratory. All feature serrated tips. Non-sterile, autoclavable.

Item No.	Description
FRSS14	Stainless Steel Forceps, Blunt, 5"
FOBL05	Stainless Steel Forceps, Economy Blunt, 5"
FOBLC5	Stainless Steel Forceps, Angular Blunt, 5"
FOMF05	Stainless Steel Forceps, Sharp, 5"
FOBL45	Stainless Steel Forceps, Economy Blunt, 4.5"



Plastic Forceps, PP

These 4.5" long polypropylene forceps feature serrated inside tips and ribbed finger supports. Non-sterile, autoclavable.

Item No.	Description
FOBPP5	Plastic Forceps, PP

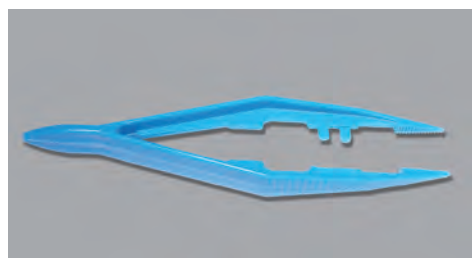

Plastic Tweezers, PP

These polypropylene tweezers are 4" long and feature serrated tips. Non-sterile, autoclavable. Sold as a pack of 12.

Item No.	Description
P1012-1	Plastic Tweezers, PP, pack of 12



Funnels, Long Stem, Borosilicate Glass

These borosilicate glass funnels include 60° cone angle, beaded tops, and long stems.

Item No.	Approx. Top Dia. (mm)	Stem Length (mm)	Overall Length (mm)	Quantity per pack	Quantity per case
GF6140-50	50	150	195	6	12
GF6140-65	65	150	205	6	12
GF6140-75	75	150	215	6	12
GF6140-100	100	150	235	6	6



Funnels, Powder, PE

A good quality polyethylene powder funnel for general lab use.

Item No.	Capacity (oz.)	Overall Height (mm)	Top Inside Diameter (mm)	Stem Length (mm)	Quantity per pack
FPP100	5	95	105	23	6



Labware Funnels



Funnels, Short Stem, Plastic

These powder funnels feature wide, short stems. The 35ml and 300ml sizes are made of high density polyethylene, and the 100ml size is made of polypropylene.

Item No.	Capacity (ml)	Top Outside Diameter (mm)	Stem Length (mm)	Quantity per pack
FHD165	35	65	20	12
FHD185	100	85	30	12
FHD125	300	125	38	12



Funnels, Industrial, PP

Heavy-duty polypropylene funnels include a molded-in handle. Designed to provide convenient filling of carboys, drums and barrels.

Item No.	Capacity (oz.)	Overall Height (mm)	Top Inside Diameter (mm)	Stem Length (mm)	Quantity per pack
57231	48	240	195	85	1
57232	84	300	245	90	1

Funnels, Powder, PP

Polypropylene funnels have short, wide stems for convenient use with powders. Autoclavable.

Item No.	Capacity (oz.)	Overall Height (mm)	Top Inside Diameter (mm)	Stem Length (mm)	Quantity per pack
57221	2	65	65	22	12
57222	3	85	78	30	12
57223	5	105	100	33	6
57224	16	135	145	30	6



Funnels, Standard Stem, PP

These clear funnels have long stems, smooth walls and external ribs to prevent air lock. Molded in polypropylene. Autoclavable.

Item No.	Capacity (ml)	Top Outside Diameter (mm)	Stem Length (mm)	Quantity per pack
FSP55	20	57	40	12
FSP65	45	67	65	12
FSP75	75	79	70	12
FSP10	150	101	85	6
FSP150	500	150	110	6

Funnels, Utility, PP

Available in three sizes, these funnels have eight internal ribs to facilitate filtration. They are made of polypropylene.

Item No.	Capacity (ml)	Top Outside Diameter (mm)	Stem Length (mm)	Quantity per pack
FPPC35	5	37	30	12
FPPC52	25	56	30	12
FPPC65	40	67	30	12
FPPC03-PK/3	One each of the above 3 funnels.			



Scan to view demonstration video



Buchner Funnels, Porcelain

Porcelain Buchner funnels include fixed perforated plates. Funnels are glazed on inner and outer surfaces except for the rims.

Item No.	Approx. Capacity (ml)	Top Dia. x Height (mm)	For Filter Paper Size (cm)	Quantity per pack
JBF003	3	20 x 66	1.3	1
JBF035	35	50 x 91	4	1
JBF100	100	65 x 103	5.5	1
JBF200	200	86 x 140	7	1
JBF350	350	105 x 162	9	1
JBF600	600	127 x 194	11	1
JBF800	800	143 x 200	12.5	1
JBF1150	1150	172 x 220	15	1
JBF2000	2000	210 x 272	18	1
JBF4800	4800	270 x 352	24	1

Buchner Funnels, Porcelain, Economy

Good quality glazed porcelain. Acid and alkali resistant. Sold as eaches.

Item No.	Approx. Capacity (ml)	Top Dia. x Height (mm)	For Filter Paper Size (cm)	Quantity per pack
PBF050	50	50 x 90	4	1
PBF070	120	70 x 125	5.5	1
PBF090	200	90 x 155	7	1
PBF110	400	110 x 165	11	1
PBF150	650	150 x 220	12.5	1
PBF200	900	200 x 250	18	1
PBF250	1200	250 x 280	24	1



Funnels, Buchner, PP

These polypropylene two-piece funnels are light-weight, easy to clean and autoclavable. The top portion snaps into the lower one, forming a vacuum seal that does not require greasing. The base of the top portion has a perforated filter plate.

Item No.	Capacity (ml)	Top O.D. (mm)	Stem Length (mm)	Filter Paper Size (cm)	Quantity per pack
57105	125	80	60	7	12
57105-A	300	104	70	9	12
57106	650	136	85	11	12

NEW PRODUCT

Buchner Funnel, Table Type

These autoclavable, table type Buchner funnels are ideal for vacuum filtration. Includes a tubulated side outlet and accepts standard filters.

Item No.	Capacity (ml)	Height x Diameter (mm)	Filter Paper Size	Side Outlet O.D.
JTTBF750	750	60 x 147	125mm	5/8" / 16mm
JTTBF1900	1900	122 x 215	180mm	1" / 25mm

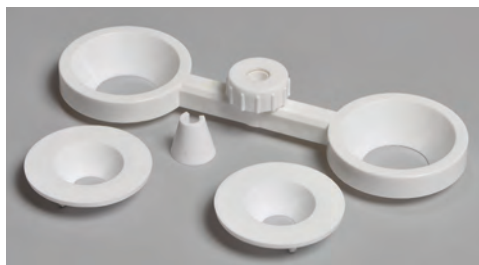

Funnel Holder, Double, PP

Suspend two funnels simultaneously using this polypropylene holder. These corrosion-resistant holders can be used with 3" to 6" diameter funnels, and include an extra plate to accommodate 1" to 3" diameter funnels. Two tapered wedges are provided to ensure firm grip on rods measuring 1/2" or 3/8" diameter.

Item No.	Description	Quantity per pack
45106	Funnel Holder, Double, PP	6



Funnel Holder, Single, PP

This corrosion-resistant polypropylene holder can be used with 3" to 6" diameter funnels, and includes an extra plate to accommodate 1" to 3" diameter funnels. Two tapered wedges are provided to ensure firm grip on rods measuring 1/2" or 3/8" diameter.

Item No.	Description	Quantity per pack
45103	Funnel Holder, Single, PP	12



Separatory Funnel Holder, PP

This non-corrosive separatory funnel holder, molded in polypropylene, has a front opening which provides clear view of the solution and allows unobstructed placement of separating funnels. Two tapered wedges are provided to ensure firm grip on rods measuring 1/2" or 3/8" diameter.

Item No.	Description	Quantity per pack
45104	Separatory Funnel Holder, PP	12



Hirsch Funnel, Porcelain

Porcelain funnels feature fixed perforated plates. Glazed on inner and outer surfaces except for the rim.

Item No.	Approx. Capacity (ml)	Top Dia. x Height (mm)	For Filter Paper Dia. (mm)	Quantity per pack
JHF010	10	30 x 50	10	1
JHF012	12	40 x 70	15	1
JHF025	25	50 x 75	30	1
JHF050	50	75 x 130	47	1
JHF140	140	100 x 175	55	1



Buchner Funnel with Fritted Disc, Borosilicate Glass

Manufactured from thick walled borosilicate glass, funnels include a beaded rim and a fritted disc with coarse, medium or fine porosity.

Item No.	Cap. (ml)	Disc Dia. (mm)	Height Above Disc (mm)	Stem O.D. (mm)	Porosity	Qty per pack
BF256-15C	15	20	45	8	Coarse	2
BF256-15M	15	20	45	8	Medium	2
BF256-15F	15	20	45	8	Fine	2
BF256-30C	30	30	45	8	Coarse	2
BF256-30M	30	30	45	8	Medium	2
BF256-30F	30	30	45	8	Fine	2
BF256-60C	60	40	50	10	Coarse	2
BF256-60M	60	40	50	10	Medium	2
BF256-60F	60	40	50	10	Fine	2

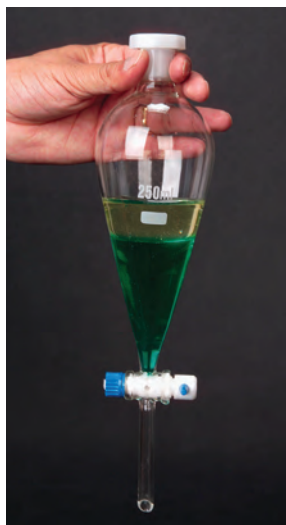

Separatory Funnels, Borosilicate Glass

These pear-shaped borosilicate glass funnels include a PTFE stopcock and a plastic stopper. Feature a marking spot and large white block letters for easy identification of capacity, as per ASTM E1096. PTFE stopcocks are compliant with ASTM standard E675.

Item No.	Capacity (ml)	Stopper Size	Quantity per pack	Quantity per case
SF149-125	125	22	2	20
SF149-250	250	22	2	20
SF149-500	500	27	2	20
SF149-1000	1000	27	1	10
SF149-2000	2000	38	1	10



Separatory Funnels, PP

These pear-shaped polypropylene separating funnels feature excellent clarity and strength, and include a leak-proof threaded screw cap. The polypropylene stopcock is fitted with a self-lubricating PTFE plug. Not graduated.

Item No.	Capacity (ml)	Top Outside Diameter (mm)	Stem Length (mm)	Quantity per pack
81201	100	55	45	1
81202	250	75	45	1
81203	500	90	45	1



NEW PRODUCT

Magnetic Stir Bars, Cross-Shaped

Our magnetic stir bars are constructed of high quality magnets coated with PTFE. Cross-shaped stir bars increase turbulence and improve stirring action.

Item No.	Description
MXB38	Magnetic Stir Bar, Cross-Shaped, 38 x 38mm
MXB42	Magnetic Stir Bar, Cross-Shaped, 42 x 42mm



Magnetic Stir Bars

Our magnetic stir bars are constructed of high quality magnets coated with PTFE. Along with individual sizes of polygon, octagon, and egg-shaped, two convenient assortments are available. Stir bar retrievers also available.

Item No.	Description	Dimensions (Length x Diameter)
MSB15	Stir Bar, Octagon, with pivot ring	15mm x 7.5mm
MSB25	Stir Bar, Octagon, with pivot ring	25mm x 8mm
MSB35	Stir Bar, Octagon, with pivot ring	35mm x 9mm
MSB40	Stir Bar, Octagon, with pivot ring	40mm x 8mm
MSB48	Stir Bar, Octagon, with pivot ring	48.5mm x 10mm
MSZ12	Stir Bar, Polygon, without pivot ring	12mm x 3mm
MSZ25	Stir Bar, Polygon, without pivot ring	25mm x 8mm
MSZ40	Stir Bar, Polygon, without pivot ring	40mm x 8mm
MSZ70	Stir Bar, Polygon, without pivot ring	70mm x 9mm
MSHL15	Stir Bar, Egg-shaped, blunt edges	15mm x 7mm
MSHL30	Stir Bar, Egg-shaped, blunt edges	30mm x 13mm
MSHL50	Stir Bar, Egg-shaped, blunt edges	50mm x 20mm



Item No.	Description
MBR350	Magnetic Stir Bar Retriever, 350mm long

Item No.	Description
MSBA20	Magnetic Stir Bar Assortment, set of 20 (2 each of all MSB series bars, plus 2 each of MSZ12, MSZ70, MSHL15, MSHL30 and MSHL50)
MSBA50	Magnetic Stir Bar Assortment, set of 50 (5 each of all MSB series bars, plus 5 each of MSZ12, MSZ70, MSHL15, MSHL30 and MSHL50)



Digital Hot Plate / Magnetic Stirrer

This digital hot plate with magnetic stirrer features an aluminum housing with a scratch and chemical resistant stainless steel ceramic coated 6" diameter heating plate. Unit is thermally insulated so the housing is relatively cool to the touch during operation. Designed with double PT sensors, this hot plate also features a digital temperature controller, RPM controller, and time controller, all of which have independent LED displays. Built-in audible alarm at end of time cycle for safety and ease of unsupervised operation. In case of malfunction, display indicates a visual error code for easy diagnosis and resolution. Built-in RS232 port for connection to a computer. Technical specifications are listed below:

- Operates on 115V/ 60 Hz
- Maximum stir speed of 1500 RPM
- Heat output of 650 W
- 0-350°C temperature range, can be displayed in C or F
- Hot top indicator for temperatures above 50°C, even when switched off
- Master selector knob for temperature, stir speed and time settings
- Display can be toggled between hotplate and probe temperature
- Adjustable safety cutoff range of 50-400°C
- Designed for use with beakers/flasks up to 2000ml in capacity

Includes the following accessories:

- Stainless steel rod, 400mm long, 12mm diameter
- PT100 sensor probe
- Magnetic stirbar, 35mm x 9mm
- Boss head clamp

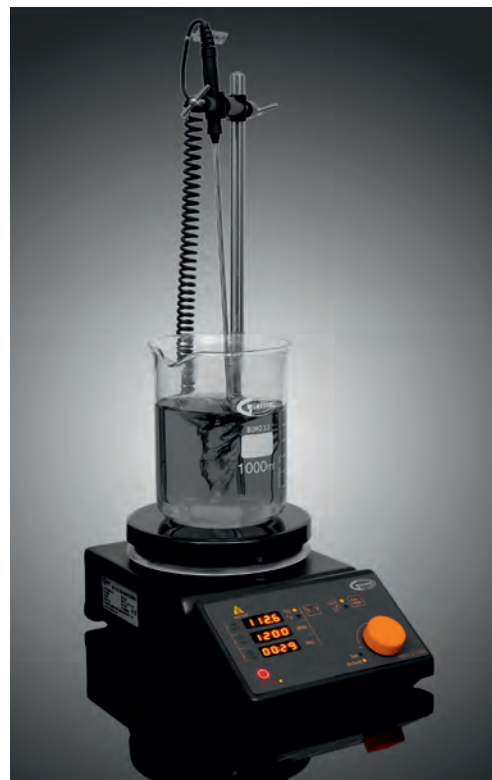

Item No.	Description
HPSD900-02	Digital Hot Plate with Magnetic Stirrer

Analog Hot Plate / Magnetic Stirrer

This analog hot plate with magnetic stirrer features knobs for electronic variable speed control and for regulating temperature. Includes a thermally insulated aluminum housing and a scratch and chemical resistant stainless steel ceramic coated 6" diameter heating plate. Temperature is safely controlled using the PT sensor. Includes a magnetic stirbar, 35mm x 9mm. Technical specifications are listed below:

- Operates on 115V/ 60 Hz
- Maximum stir speed of 1600 RPM
- Heat output of 650 W
- 0-350°C / 0-660°F temperature range
- Hot top indicator for temperatures above 50°C/ 120°F, even when switched off
- Designed for use with beakers/flasks up to 2000ml in capacity

Item No.	Description
HPSA700-02	Analog Hot Plate with Magnetic Stirrer



Scan to view demonstration video



Soxhlet Extraction Apparatus with Heating Mantle, Single Station



This unique set includes matched components to provide a convenient Soxhlet extraction workstation. The setup includes a heating mantle with stirrer, 250ml borosilicate glass boiling flask, 100ml borosilicate glass Soxhlet extractor, 300mm borosilicate glass Allihn condenser with glass connectors, sturdy powder-coated metal support stand with aluminum clamp and stability bracket, and two 48" lengths of rubber tubing with screw connectors.

The heating mantle with stirrer features a polyurethane coated aluminum exterior and a high quality knitted mantle with glass fiber underlay for uniform distribution of heat. Maximum operating temperature is 400°C. Mantle can be used in a wide range of ambient temperatures, from about 45°F to 100°F, and relative humidity up to 80%. The unit is not waterproof, and is rated as IP code 10 equipment. Stirring function operates at speeds of 50 to 750 RPM. Heating and stirring functions are independently controlled by two separate knobs.

Stand measures 20"H x 8"W with a base platform 10.5"D with a 1" lip.

Item No.	Description
HMSOX-250	Soxhlet Apparatus with Heating Mantle, Single Station

Heating Mantles

These heating mantles are designed for use with round bottom flasks. Features include polyurethane coated aluminum exteriors and a high quality knitted mantle with glass fiber underlay for uniform distribution of heat. Maximum operating temperature is 400°C. Mantles can be used in a wide range of ambient temperatures, from about 45°F to 100°F, and relative humidity up to 80%. The units are not waterproof, and are rated as IP code 10 equipment.

Power is controlled (from 0 – 100%) by a knob that is built into the unit - no need for a separate external power control unit. Mantles are designed to securely hold flasks so that the top half of the flask is easily visible during operation. Elements can be replaced easily. An outlet tube is built-in for draining any spilled liquids. A 4-foot long grounded cord is included. Each unit features a fuse that can be easily replaced.

Units are designed for long-term use. Care should be taken to avoid chemical spillage, overheating, overloading, and general misuse to maximize service life. Please refer to the user manual for more information.

Replacement elements are sold separately. Call for details.

Item No.	Mantle Capacity (ml)	Wattage (W)
HM1000-100	100	150
HM1000-250	250	150
HM1000-500	500	200
HM1000-1000	1000	300

Also available in 2 - 20L capacities by special order. Call for details.



HM1000-500



Heating Mantles with Stirrer

HMS1500 series Mantles feature stirring capability (50 – 750 RPM). Heating and stirring functions are independently controlled by 2 separate knobs. Each unit is supplied with a magnetic stir bar.

Mantles with stirrer feature polyurethane coated aluminum exteriors and a high quality knitted mantle with glass fiber underlay for uniform distribution of heat. Maximum operating temperature is 400°C. Mantles can be used in a wide range of ambient temperatures, from about 45°F to 100°F, and relative humidity up to 80%. The units are not waterproof, and are rated as IP code 10 equipment.

Power (from 0 – 100%) and stir speed (50 – 750 RPM) are controlled from 2 separate knobs that are built-into the unit. No need for a separate external control unit! Mantles are designed to securely hold flasks so that the top half of the flask is easily visible during operation. Elements can be replaced easily. An outlet tube is built-in for draining any spilled liquids. A 4-foot long grounded cord is included. Each unit features a fuse that can be easily replaced.

Units are designed for long-term use. Care should be taken to avoid chemical spillage, overheating, overloading, and general misuse to maximize service life. Please refer to the user manual for more information.

Item No.	Mantle Capacity (ml)	Wattage (W)
HMS1500-100	100	150
HMS1500-250	250	150
HMS1500-500	500	200
HMS1500-1000	1000	300
HMS1500-2000	2000	470

Also available in 3, 4 and 5L capacities by special order. Call for details.



HMS1500-250

Heating Mantles, Combo



HM6P2000-250

HM2000 series combination mantles are ideal for repetitive extracting, refluxing, and distillation applications. Units feature space saving built-in electronic power regulator knobs. Available in 3-place and 6-place configurations for maximum safety and convenience. Each unit includes 1 each stainless horizontal rod, 2 each stainless vertical rods, and either 3 or 6 each rod connecting clamps and extension clamps for holding glassware. 3-place units measure 17.75"L x 7"W x 6.5"H. 6-place unit measures 38.25"L x 7"W x 6.5"H.

Mantles feature polyurethane coated aluminum exterior and high quality knitted mantles with glass fiber underlay for uniform distribution of heat. Maximum operating temperature is 400°C. Mantles can be used in a wide range of ambient temperatures, from about 45°F to 100°F, and relative humidity up to 80%. The units are not waterproof, and are rated as IP code 10 equipment.

Power is controlled (from 0 – 100%) from knobs that are built-into the unit. No need for a separate external power control unit! Mantles are designed to securely hold flasks so that the top half of the flask is easily visible during operation. Elements can be replaced easily. An outlet tube is built-in for draining any spilled liquids. A 4-foot long 3-wire cord is included. Each unit features a fuse that can be easily replaced.

Units are designed for long-term use. Care should be taken to avoid chemical spillage, overheating, overloading, and general misuse to maximize service life. Please refer to the user manual for more information.

Replacement elements should be ordered separately. Call for details.

Item No.	Mantle Capacity (ml)	Wattage (W)	Fuse Amp	No. of position of regulator
HM3P2000-100	100	180	1	3/3
HM3P2000-250	250	450	5	3/3
HM3P2000-500	500	600	5	3/3
HM6P2000-250	250	360	??	6/6



Glassware Assortment



Quality glassware assortment for use in a laboratory. Shipped in a reusable storage box. Kit includes the following items:

Contents:

Beaker, Glass, 100ml	2	Mortar and Pestle, Porcelain	1
Beaker, Glass, 250ml	1	Cylinder, Glass, 10ml	1
Beaker, Glass, 400ml	1	Cylinder, Glass, 25ml	1
Bottles, 4 oz. w/ Screw Caps	2	Cylinder, Glass, 50ml	1
Burettes, 50ml, Mohr	2	Cylinder, Glass, 100ml	1
Crucible, Porcelain	1	Test Tubes, 13 x 100mm	6
Crucible Cover, Porcelain	1	Test Tubes, 18 x 150mm	6
Dropper, Pipet (Eye Dropper)	1	Test Tubes, 25 x 200mm	6
Dropping Bottle, 30ml, Barnes	12	Glass Capillary Tubing	4
Evaporating Dish, Porcelain	1	Flask, Erlenmeyer, 250ml	1
Funnel, Short Stem, 75mm	1	Glass Rod, 8"	1
Watch Glass, 75mm	1	Petri Dish, 100mm	2

Item No.	Description
GLSKIT1	Glassware Assortment

General Lab Glassware Starter Kit

A convenient glassware assortment designed for general laboratory use. Starter kit includes the following:

Contents:

Beaker, Set of 5	1
Beaker Tongs, 9"	1
Erlenmeyer Flasks, Set of 5	1
Cylinder, 10ml, Hex Base	1
Cylinder, 25ml, Hex Base	1
Cylinder, 100ml, Hex Base	1
Media Bottle, 100ml	1
Media Bottle, 500ml	1
Test Tube Rack (blue/yellow) with 12 Test Tubes (TT9800-F) and 12 Rubber Stoppers (RST1-S)	1
Test Tube Clamp, Steel Wire, with Grips	1
Glass Rod, 8", pk/12	1
Dropping Bottle, 30ml, Barnes, with Dropper Pipets	12



Item No.	Description
GLSKIT3	General Lab Glassware Starter Kit

Volumetric Glassware Starter Kit

A customized volumetric glassware assortment designed for general laboratory use. Starter kit includes the following:

Contents:

Burettes, 10ml Straight Bore, PTFE Stopcock	1
Cylinders, Double Scale, 50ml	1
Cylinders, Double Scale, 100ml	1
Flask, Filtering, 500ml	1
Flask, Volumetric with Snap Cap, 50ml	1
Flask, Volumetric with Snap Cap, 100ml	1
Separatory Funnel, Conical, 500ml	1
Pipettes, Measuring (Mohr Type), Class B, 10ml Capacity x .10ml Graduations, pk/6	1
Pipettes, Transfer, Volumetric, 25ml, pk/6	1



Item No.	Description
GLSKIT4	Volumetric Glassware Starter Kit



Hardware Assortment

Kit includes a variety of commonly used hardware items in a general science, physical science, or chemistry laboratory. Designed for use by 2 to 4 students. Shipped in a reusable storage box.

Contents:

Alligator Clip w/ 24" Wire	2	Rubber Stopper #0, 1-hole	2
Burette Brush	1	Rubber Stopper #3, 1-hole	2
Burette Clamp, Double	1	Rubber Stopper #6, 1-hole	2
Clamp, Boss Head	1	Rubber Stopper #6, 2-hole	2
Clay Pipe Triangle, 2"	1	Rubber Tubing, 4 feet, 1/4" I.D.	1
Crucible Tongs, Plated, 9"	1	Test Tube Clamp	2
Electrodes, Carbon Rods	2	Test Tube Brush, 3" x 1/2"	1
Metric Ruler, Plastic, 30cm	1	Test Tube Rack, 12 Holes,	
Nichrome Wire with		12 Pins, Wood	1
Aluminum Handle	1	Thermometer, 20 to 150°C	1
Pencil, Glass Marking, Blue	1	Wash Bottle, 250ml, Polyethylene	1
Pinch Clamp, Mohrs, 2-1/4"	1	Water Reservoir, Pneumatic Trough	1
Ring Stand (5" x 8" base)	1	Wire Gauze, Ceramic, 5" x 5"	1
Ring Support with 4" Clamp.	1		



Item No.	Description
HRDKIT1	Hardware Assortment

Economy Plasticware Kit

An affordable assortment of some of most commonly used plastic labware items. Kit consists of 20 items shipped in a plastic storage box.

Contents:

Beaker, 100ml	1
Beaker, 250ml	1
Graduated Cylinder, 10ml	1
Graduated Cylinder, 100ml	1
Funnel, 65mm top diameter	1
Drop Dispenser Bottle	1
Reagent Bottle	4
Wash Bottle	1
Plastic Test Tubes	3
Pipettes	6

Item No.	Description
PLKIT20	Economy Plasticware Kit



Plasticware Starter Kit



Item No.	Description
PLSKIT1	Plasticware Starter Kit

A customized plasticware assortment that is designed for general laboratory use. Starter kit includes the following:

Contents:

Beaker Set of 5 (50, 100, 250, 500 & 1000ml)	1
Graduated Cylinder Set of 4 (10, 25, 50 & 100ml)	1
Wash Bottle, 250ml	1
Wash Bottle, 500ml	1
Reagent Bottle, PP, Narrow Mouth, 250ml	1
Reagent Bottle, PP, Narrow Mouth, 500ml	1
Reagent Bottle, PP, Wide Mouth, 250ml	1
Reagent Bottle, PP, Wide Mouth, 500ml	1
Measuring Jug, 500ml	1
Measuring Jug, 1000ml	1



Porcelainware Starter Kit

A customized kit that includes our top-selling porcelain products. Starter kit includes the following:

Contents:

- Crucible, Porcelain, Low Form, 50ml capacity (JCL050)1
- Crucible, Porcelain, High Form, 50ml capacity (JCT050)1
- Casserole, Porcelain, 200ml capacity (JPC200)1
- Mortar and Pestle, 275ml capacity (JMD275)1
- Evaporating Dish, 80ml capacity (JED080)1
- Clay Pipe Triangle, 2" (CPT020)1
- Crucible Tongs, Nickel Plated, Steel, 9" (CTSP09)1

Item No.	Description
PORTKIT2	Porcelainware Starter Kit



Porcelainware Starter Kit, Economy

A customized kit that includes our top-selling porcelain products. Starter kit includes the following:

Contents:

- Crucible, Porcelain, Low Form, 50ml1
- Crucible, Porcelain, High Form, 50ml1
- Casserole, Porcelain, 220 ml capacity1
- Mortar and Pestle, 125mm I.D., 500ml capacity1
- Evaporating Dish, 82mm diameter, 75ml capacity1
- Clay Pipe Triangle, 2"1
- Crucible Tongs, Nickel Plated, Steel, 9"1

Item No.	Description
PORTKIT1	Porcelainware Starter Kit, Economy



Plastic Labware Value Set

Economical, and convenient starter kit or refresher set. Includes an assortment of popular plastic labware items. All items in the set except wash bottles are autoclavable. Set includes 26 labware items in addition to 12 plastic tubes.

Contents:

- Beakers (50, 100, 250, 500 & 1000ml)5
- Graduated Cylinders (10, 25, 50, 100, 250, 500 1000ml)7
- Wash Bottles, Unitary, 500ml4
- Storage Bottles, Square, Wide Mouth, 500ml6
- Erlenmeyer Flasks, Wide Mouth, with cap, 250ml3
- Test Tube Rack, with 12 tubes1

Item No.	Description
PLSKIT2	Plastic Labware Value Set



Scan to view demonstration video



NEW PRODUCT

Deluxe Laboratory Tools Kit

Convenient assortment of seven commonly used laboratory tools. Contains one each of the following items: 6-hole test tube rack, test tube brush, test tube clamp, spatula, crucible tongs, lab scoop, and forceps.

Item No.	Description
LSET7	Deluxe Laboratory Tools Kit, Set of 7



Laboratory Tools Kit

An assortment of six of the most commonly used laboratory tools, available as one convenient set. Contains one each of following: test tube brush, spatula, crucible tongs, test tube clamp, lab scoop, and forceps.

Item No.	Description
LSET6	Laboratory Tools Kit



Laboratory Coats

Knee-length lab coats made of easy care white cotton blend fabric (65% polyester, 35% cotton). Our coats feature one upper left breast pocket, two roomy lower pockets, side pocket slit openings, and a sewn-down back belt.

Tie-dyed Laboratory Coats

Featuring a vibrant tie-dyed pattern, these knee length coats are made of easy care 100% cotton. Coats feature one upper left breast pocket, two roomy lower pockets, side slit openings, and a sewn-down back belt.

Item No.	Description
MEN:	
LCMXS1	Men's Lab Coat, Extra Small, size 34
LCMS01	Men's Lab Coat, Small, size 36
LCMM01	Men's Lab Coat, Medium, size 40
LCML01	Men's Lab Coat, Large, size 44
LCMXL1	Men's Lab Coat, Extra Large, size 48
LCMXXL1	Men's Lab Coat, Double Extra Large, size 50
LCM3XL1	Men's Lab Coat, Triple Extra Large, size 52
WOMEN*:	
LCLS01	Women's Lab Coat, Small, size 4-6
LCLM01	Women's Lab Coat, Medium, size 8-10
LCLL01	Women's Lab Coat, Large, size 12-14
LCLXL1	Women's Lab Coat, Extra Large, size 16-18
LCLXXL1	Women's Lab Coat, Double Extra Large, size 20-22

Item No.	Description
LBCTSM	Tie-dyed Lab Coat, Small
LBCTMD	Tie-dyed Lab Coat, Medium
LBCTLG	Tie-dyed Lab Coat, Large
LBCTXL	Tie-dyed Lab Coat, Extra Large
LBCT2XL	Tie-dyed Lab Coat, Double Extra Large

* Women's sizes correspond to women's dress sizes.



NEW PRODUCT

Vinyl Laboratory Aprons

These aprons are made of a chemical resistant vinyl fabric which stays flexible. There is reinforcement at the points of strain. Aprons include cloth ties at the neck and waist.

Laboratory Aprons

These aprons are made of a chemical resistant PVC-coated fabric which stays flexible. There is reinforcement at the points of strain. Aprons include cloth ties at the neck and waist.

Item No.	Description
LAVL01	Vinyl Apron, Small (24" x 30")
LAVL02	Vinyl Apron, Medium (27" x 36")
LAVL03	Vinyl Apron, Large (27" x 42")
LAVL04	Vinyl Apron, Extra Large (36" x 46")

Item No.	Description
LBAP01	Lab Apron, 36" x 27"
LBAP02	Lab Apron, 42" x 27"
LBAP03	Lab Apron, 42" x 36"
LBAP04	Lab Apron, 46" x 36"



Mortar and Pestle Sets, Agate Stone

Octagonal mortar and pestle sets feature highly polished grinding surfaces. Made of naturally hard agate stone (6.5 on Moh's Scale). For use in laboratories demanding contamination-free results. Physical dimensions have a tolerance of +/- 3mm. Note that the natural agate material causes surface pattern variations in finished mortars and pestles.

Item No.	Mortar Top O.D. (mm)	Capacity (ml)	Mortar Height (mm)	Pestle Length (mm)	Quantity per pack
MPA015	38	5	25	38	1
MPA020	65	10	28	50	1
MPA030	76	25	34	76	1
MPA035	89	50	38	88	1
MPA040	102	75	41	101	1
MPA060	152	250	65	152	1

Mortar and Pestle Sets, Deep Form, Porcelain

Deep form mortars with lips are glazed on the outside (except for the bottom) and unglazed inside. Oversized pestles are glazed to grinding surface.

Item No.	Capacity (ml)	Mortar Height (mm)	Pestle Length (mm)	Quantity per pack
JMD050	50	47	95	1
JMD070	70	52	115	1
JMD150	150	70	135	1
JMD275	275	70	160	1
JMD400	400	80	185	1
JMD750	750	110	200	1
JMD1900	1900	130	222	1



Mortar and Pestle Sets, Porcelain, Economy

Mortars have pouring spout, are glazed outside only, with porcelain pestles glazed to grinding surface.

Item No.	Capacity (ml)	Mortar I.D. (mm)	Pestle Length (mm)	Quantity per pack
PPM060	80	60	95	1
PPM075	125	75	115	1
PPM100	300	100	135	1
PPM125	500	125	165	1



Pipettes, Transfer, Volumetric, Class B

These pipettes are made from borosilicate glass in compliance with ASTM specification E969 for Class B pipettes. Color-coded. Calibrated to deliver. Printed with durable amber markings.



Item No.	Capacity (ml)	Tolerance (ml)	Color	Quantity per pack
PT7102-A	1	± 0.012	Blue	6
PT7102-B	2	± 0.012	Orange	6
PT7102-C	5	± 0.020	White	6
PT7102-D	10	± 0.040	Red	6
PT7102-E	20	± 0.060	Yellow	6
PT7102-F	25	± 0.060	Blue	6
PT7102-G	50	± 0.100	Red	6
PT7102-H	100	± 0.160	Yellow	6

Pipettes, Measuring (Mohr), Class B



These pipettes are made from borosilicate glass in compliance with ASTM specification E1293 for Class B pipettes. Color-coded. Calibrated to deliver. Printed with durable amber markings.

Item No.	Capacity (ml)	Graduation Interval (ml)	Tolerance	Color Code	Quantity per pack
PM7060-A	0.1	0.01	± 0.005	White	6
PM7060-B	0.2	0.01	± 0.008	Black	6
PM7060-C	1.0	0.01	± 0.020	Yellow	6
PM7060-D	1.0	0.1	± 0.020	Red	6
PM7060-F	2.0	0.1	± 0.020	Green	6
PM7060-H	5.0	0.1	± 0.040	Blue	6
PM7060-I	10.0	0.1	± 0.060	Orange	6
PM7060-J	25.0	0.1	± 0.100	White	6

Pipettes, Serological, Accuracy as per Class B

These Type 3 serological pipettes are made from borosilicate glass and comply with USP standards. Color-coded. Calibrated to deliver. Printed with durable amber markings.

Item No.	Capacity (ml)	Graduation Interval (ml)	Tolerance (ml)	Color Code	Quantity per pack
PS7080-A	0.1	0.01	± 0.005	White	6
PS7080-B	0.2	0.01	± 0.008	Black	6
PS7080-C	1.0	0.01	± 0.020	Yellow	6
PS7080-D	1.0	0.1	± 0.020	Red	6
PS7080-F	2.0	0.1	± 0.020	Green	6
PS7080-H	5.0	0.1	± 0.040	Blue	6
PS7080-I	10.0	0.1	± 0.060	Orange	6
PS7080-J	25.0	0.1	± 0.100	White	6

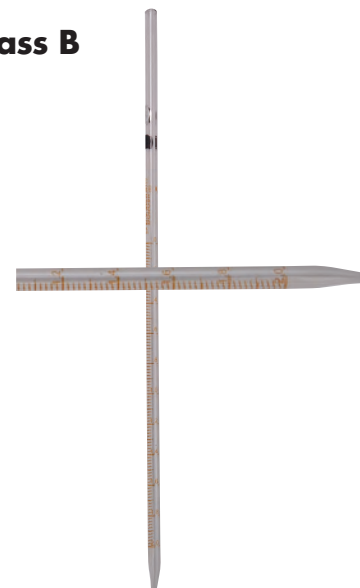



Labware Pipettes



Pipettes, Measuring (Mohr), Class A, Batch Certified

These pipettes are made from borosilicate glass in compliance with ASTM specification E1293. Color-coded. Batch certified. Calibrated to deliver. Printed with durable amber markings.



Item No.	Capacity (ml)	Graduation Interval (ml)	Tolerance (ml)	Color Code	Quantity per pack
PM7059-A	0.1	0.01	± 0.006	White	5
PM7059-B	0.2	0.01	± 0.006	Black	5
PM7059-D	1	0.10	± 0.010	Red	5
PM7059-F	2	0.10	± 0.010	Green	5
PM7059-H	5	0.10	± 0.020	Blue	5
PM7059-I	10	0.10	± 0.030	Orange	5
PM7059-J	25	0.10	± 0.050	White	5

Pipettes, Measuring (Mohr), Class A, Individually Certified

These pipettes are made from borosilicate glass in compliance with ASTM specification E1293. Color-coded. Individually serialized and certified. Calibrated to deliver. Printed with durable amber markings.

Item No.	Capacity (ml)	Graduation Interval (ml)	Tolerance (ml)	Color Code	Quantity per pack
PM7058-A	0.1	0.01	± 0.006	White	5
PM7058-B	0.2	0.01	± 0.006	Black	5
PM7058-D	1	0.10	± 0.010	Red	5
PM7058-F	2	0.10	± 0.010	Green	5
PM7058-H	5	0.10	± 0.020	Blue	5
PM7058-I	10	0.10	± 0.030	Orange	5
PM7058-J	25	0.10	± 0.050	White	5



Pipettes, Serological, Class A, Individually Certified

These Type 3 serological pipettes are made from borosilicate glass and comply with USP standards. Color-coded. Individually serialized and certified. Calibrated to deliver. Printed with durable amber markings.

Item No.	Capacity (ml)	Graduation Interval (ml)	Tolerance (ml)	Color Code	Quantity per pack
PS7078-A	0.1	0.01	± 0.006	White	5
PS7078-B	0.2	0.01	± 0.006	Black	5
PS7078-D	1	0.10	± 0.010	Red	5
PS7078-F	2	0.10	± 0.010	Green	5
PS7078-H	5	0.10	± 0.020	Blue	5
PS7078-I	10	0.10	± 0.030	Orange	5
PS7078-J	25	0.10	± 0.050	White	5





Pipettes, Transfer, Volumetric, Class A, Batch Certified

These pipettes are made from borosilicate glass in compliance with ASTM specification E969. Color-coded. Batch certified. Calibrated to deliver. Printed with durable amber markings.

Item No.	Capacity (ml)	Tolerance (ml)	Color	Quantity per pack
PT7101-A	1	± 0.006	Blue	5
PT7101-B	2	± 0.006	Orange	5
PT7101-C	5	± 0.010	White	5
PT7101-D	10	± 0.020	Red	5
PT7101-E	20	± 0.030	Yellow	5
PT7101-F	25	± 0.030	Blue	5
PT7101-G	50	± 0.050	Red	5
PT7101-H	100	± 0.080	Yellow	5



Pipettes, Transfer, Volumetric, Class A, Individually Certified

These pipettes are made from borosilicate glass in compliance with ASTM specification E969. Color-coded. Individually serialized and certified. Calibrated to deliver. Printed with durable amber markings.



Item No.	Capacity (ml)	Tolerance (ml)	Color	Quantity per pack
PT7100-A	1	± 0.006	Blue	5
PT7100-B	2	± 0.006	Orange	5
PT7100-C	5	± 0.010	White	5
PT7100-D	10	± 0.020	Red	5
PT7100-E	20	± 0.030	Yellow	5
PT7100-F	25	± 0.030	Blue	5
PT7100-G	50	± 0.050	Red	5
PT7100-H	100	± 0.080	Yellow	5

Pipettes, Serological, Class A, Batch Certified

These Type 3 serological pipettes are made from borosilicate glass and comply with USP standards. Color-coded. Batch certified. Calibrated to deliver. Printed with durable amber markings.



Item No.	Capacity (ml)	Graduation Interval (ml)	Tolerance (ml)	Color Code	Quantity per pack
PS7079-A	0.1	0.01	± 0.006	White	5
PS7079-B	0.2	0.01	± 0.006	Black	5
PS7079-D	1	0.10	± 0.010	Red	5
PS7079-F	2	0.10	± 0.010	Green	5
PS7079-H	5	0.10	± 0.020	Blue	5
PS7079-I	10	0.10	± 0.030	Orange	5
PS7079-J	25	0.10	± 0.050	White	5



Pipette Filling Device

Fill any standard pipette using this efficient and reliable electronic instrument. It is designed for ease and comfort to suit various types of liquid handling needs in laboratories.

Features include LED charging indicators, adjustable pump speed, comfort grip and multiple housing color combinations. A universal silicon collet is provided to accept all standard pipettes up to 100ml. Internal knurlings on the collet hold the pipette firmly.

An in-line membrane filter (0.2 micron filter included) prevents aerosol contamination and prevents liquid from entering the equipment by accident.

Ni-MH 3.6V batteries are used in combination with a low power consumption circuit and vacuum/pressure pump. This allows for eight hours of continuous operation. Each device includes a battery charger that plugs into a standard wall outlet.

Item No.	Description
PFD001	Pipette Filling Device
PFDS01	Stand for Pipette Filling Device
Replacement Filters:	
MPF-20-pk/5	Replacement filters 0.2 µm
MPF-45-pk/5	Replacement filters 0.45 µm



MPF-20-pk/5



MPF-45-pk/5



PFDS01



Pipette Filling Device can be private-labeled.
Please call for details.



Adjustable Pump Speed:
Control knob allows easy adjustment of pump speed, even while the unit is operating.



Status Indicator LEDs:
Red LED indicates low charge and green LED indicates that battery is charged.



Comfortable Grip:
Ergonomic handle is designed for extended use.



Universal Collet:
A universal silicon collet with internal knurlings firmly holds all standard pipettes up to 100ml.

Pipette Pumps



Good quality pipettors designed for easy and precise pipetting. Pumps feature a lever for quick release, and forward or backward wheel movement. The soft elastic chuck has a threaded collar to tightly grip glass or plastic pipettes. Easy to clean.

Item No.	Capacity (ml)	Color	Quantity per pack
PPMP02	2	Blue	12
PPMP10	10	Green	12
PPMP25	25	Red	12



Mini Pipettes

These mini pipettes include a two step plunger that facilitates super blow-out from the tip (last drop dispensing), resulting in very high accuracy and precision. This allows the mini pipette to be used for reverse pipetting and repetitive pipetting.

The tip cone of the 5µl, 10µl, and 20µl mini pipettes is designed to accept both standard 200µl tips or ultra micro tips up to 20µl. Use of ultra micro tips for volumes up to 20µl enhances accuracy and precision. Can be used for reverse pipetting and repetitive pipetting.

These pipettes provide an optimum length of 130mm for user comfort during pipetting, and are fully autoclavable at 121°C, 15 psi for 10 to 15 minutes. Plungers are color coded for different volumes for easy identification in the lab.



Item No.	Capacity (µl)	Accuracy (± %)	Precision (≤ %)	Compatible Tips	Color
PMP005	5	1.5	1.0	T200UL-N	Dark Green
PMP010	10	1.0	1.0	T200UL-N	Pink
PMP020	20	0.5	0.5	T200UL-N	Green
PMP025	25	0.5	0.5	T200UL-N	Purple
PMP050	50	0.4	0.3	T200UL-N	Gray
PMP100	100	0.3	0.3	T200UL-N	Brown
PMP200	200	0.5	0.5	T200UL-N	Yellow
PMP250	250	0.5	0.5	T1000UL-N	Light Green
PMP500	500	0.5	0.5	T1000UL-N	Blue
PMP1000	1000	0.5	0.5	T1000UL-N	Black



Color Coding:

Different volume range mini pipette plungers are color-coded for easy identification.



Optimum Shape:

Unique design can be held like a micropipette, not a syringe!



Two-step Plunger:

Two-step plunger operation facilitates super blow-out from the tip (last drop dispensing), resulting in very high accuracy and precision.



Optimum Size:

130mm length was chosen to provide comfort for all users.



Unique Tip Cone

Designed to accept both regular 200µl tips or ultra micro tips up to 20µl.



Variable Volume Fully Autoclavable Micropipettes

Our Variable Volume Micropipettes feature built-in tip ejectors and autoclavable tip cones. They are offered in nine volume ranges, as detailed below. They work on a click stop digital system, are easy to calibrate and maintain, and easy to disassemble for autoclaving. Manufactured in an ISO 9001:2008 certified facility, these pipettes are highly accurate. Each pipette is individually calibrated according to ISO 8655 standards. A calibration certificate is provided with each pipette.



Item No.	Volume Range	Increment (µl)	Volume (µl)	Accuracy (± %)	Precision (≤ %)	Compatible Tips
PRV-2	0.2-2.0 µl	0.01	0.2	12.0	6.0	20 µl
			1.0	2.5	1.5	T20UL-N
			2.0	1.5	0.7	
PRV-10	0.5-10 µl	0.1	0.5	5.0	2.8	200 µl
			5.0	1.5	0.8	T200UL-N
			10.0	1.0	0.4	
PRV-20	2-20 µl	0.1	2.0	5.0	1.5	200 µl
			10.0	1.0	0.6	T200UL-N
			20.0	1.0	0.3	
PRV-50	5-50 µl	1.0	5.0	2.5	1.5	200 µl
			25.0	0.7	0.3	T200UL-N
			50.0	0.7	0.3	
PRV-100	10-100 µl	1.0	10.0	2.5	0.7	200 µl
			50.0	0.8	0.3	T200UL-N
			100.0	0.8	0.15	
PRV-200	20-200 µl	1.0	20.0	2.5	0.7	200 µl
			100.0	1.0	0.3	T200UL-N
			200.0	0.6	0.2	
PRV-1000	100-1000 µl	10.0	100.0	1.6	0.3	1000 µl
			500.0	0.6	0.2	T1000UL-N
			1000.0	0.5	0.2	
PRV-5000	0.5-5 ml	100.0	500.0	1.5	0.3	5 ml
			2500.0	0.6	0.2	T5ML-N
			5000.0	0.6	0.2	
PRV-10000	2-10 ml	100.0	1000.0	1.5	0.3	10 ml
			5000.0	0.6	0.2	T10ML-N
			10000.0	0.6	0.2	



Easy Volume Adjustment:
Easy volume adjustment by simply turning the plunger. Plunger does not snag gloves.



Volume Setting:
Soft click sound at every increment ensures perfect volume setting and no accidental volume change. It also facilitates single handed operation.



Digital Display:
Four-digit display with subdivisions provides small volume increments.



Large Grip:
Specially designed large grip is provided for comfort during frequent use.



Tip Ejector:
Built-in streamlined tip ejector facilitates easy tip ejection and access to narrow necked bottles and tubes.



User Adjustment:
Re-calibration can be performed.

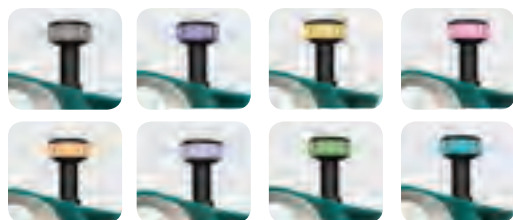

Color Coding:
Different volume range micropipette dials are color-coded for easy identification.

Micropipettes can be private labeled with your name and logo. Fixed Volume Micropipettes can also be special ordered. Please call for details.



Multichannel Fully Autoclavable Micropipettes

Our Multichannel micropipettes are recommended for a wide variety of applications such as ELISA, molecular screening, kinetic studies, and DNA amplifications. Available in 8-channel and 12-channel options.

Our Variable Volume Micropipettes feature built-in tip ejectors and autoclavable tip cones. They work on a click stop digital system, are easy to calibrate and maintain, and easy to disassemble for autoclaving. Manufactured in an ISO 9001:2008 certified facility, these pipettes are highly accurate. Each pipette is individually calibrated according to ISO 8655 standards and includes a calibration certificate.

8-Channel Item No.	12-Channel Item No.	Volume Range	Increment (µl)	Volume (µl)	Accuracy (± %)	Precision (≤ %)	Compatible Tips
PMC8-10	PMC12-10	0.5-10 µl	0.1	1.0	4.00	4.00	200 µl
				5.0	2.50	2.50	T200UL-N
				10.0	1.50	1.50	
PMC8-20	PMC12-20	2-20 µl	0.1	2.0	4.00	4.00	200 µl
				10.0	1.50	1.50	T200UL-N
				20.0	1.50	1.00	
PMC8-50	PMC12-50	5-50 µl	1.0	5.0	3.00	2.00	200 µl
				25.0	1.50	1.00	T200UL-N
				50.0	0.50	0.50	
PMC8-100	PMC12-100	10-100 µl	1.0	10.0	3.00	1.50	200 µl
				50.0	1.00	0.50	T200UL-N
				100.0	1.00	0.50	
PMC8-200	PMC12-200	20-200 µl	1.0	20.0	2.00	0.80	200 µl
				100.0	1.00	0.50	T200UL-N
				200.0	0.70	0.25	
PMC8-300	PMC12-300	40-300 µl	1.0	40.0	2.00	0.80	1000 µl
				150.0	1.00	0.50	T1000UL-N
				300.0	0.70	0.25	



Our Variable Volume Micropipettes feature built-in tip ejectors and autoclavable tip cones. They are offered in nine volume ranges, as detailed below. They work on a click stop digital system, are easy to calibrate and maintain, and easy to disassemble for autoclaving. Manufactured in an ISO 9001:2008 certified facility, these pipettes are highly accurate. Each pipette is individually calibrated according to ISO 8655 standards. A calibration certificate is provided with each pipette.

Variable Volume Semi-Autoclavable Micropipettes

Item No.	Volume Range	Increment (µl)	Volume (µl)	Accuracy (± %)	Precision (≤ %)	Compatible Tips
PVV-2	0.2-2.0 µl	0.01	0.2	12.0	6.0	20 µl
			1.0	2.5	1.5	
			2.0	1.5	0.7	
PVV-10	0.5-10 µl	0.1	0.5	5.0	2.8	200 µl
			5.0	1.5	0.8	
			10.0	1.0	0.4	
PVV-20	2-20 µl	0.1	2.0	5.0	1.5	200 µl
			10.0	1.0	0.6	
			20.0	1.0	0.3	
PVV-50	5-50 µl	1.0	5.0	2.5	1.5	200 µl
			25.0	0.7	0.3	
			50.0	0.7	0.3	
PVV-100	10-100 µl	1.0	10.0	2.5	0.7	200 µl
			50.0	0.8	0.3	
			100.0	0.8	0.15	
PVV-200	20-200 µl	1.0	20.0	2.5	0.7	200 µl
			100.0	1.0	0.3	
			200.0	0.6	0.2	
PVV-1000	100-1000 µl	10.0	100.0	1.6	0.3	1000 µl
			500.0	0.6	0.2	
			1000.0	0.5	0.2	
PVV-5000	0.5-5 ml	100.0	500.0	1.5	0.3	5 ml
			2500.0	0.6	0.2	
			5000.0	0.6	0.2	
PVV-10000	2-10 ml	100.0	1000.0	1.5	0.3	10 ml
			5000.0	0.6	0.2	
			10000.0	0.6	0.2	

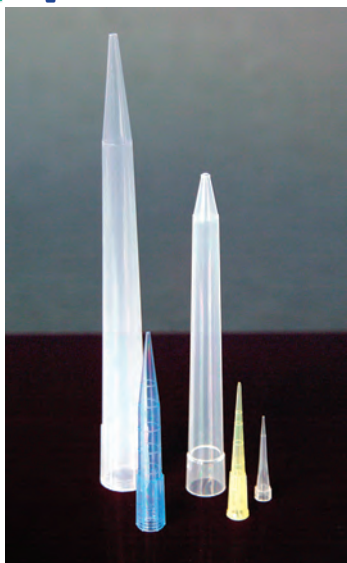

Micropipette Tips, PP

Manufactured in a precision molding facility from 100% virgin polypropylene, United micropipette tips are DNase, RNase and Pyrogen free. The highly smooth surface is hydrophobic to provide low liquid retention, increased accuracy and repeatability. Inner radial rings enable an airtight grip on the tip cone. Autoclavable at 121°C and 15 psi for 30 minutes.

United tips are compatible with many leading brands of pipettes, such as Eppendorf, Gilson, and Rainin. Please call for a complete list of compatible micropipette models.

Item No.	Tip Size	Description / Color	Quantity per pack
T10UL-N	10 µl	Natural	1,000
T20UL-N	20 µl	Natural	1,000
T200UL-Y	200 µl	Yellow	1,000
T200UL-N	200 µl	Natural	1,000
T1000UL-B	1000 µl	Blue	500
T1000UL-N	1000 µl	Natural	500
T5ML-N	5 ml	Natural	500
T10ML-N	10 ml	Natural	400



Racked Micro Tips, Sterile, PP

Sterile tips are packaged in racks of 96 with 10 racks in each case.

Manufactured in a precision molding facility from 100% virgin polypropylene, United micropipette tips are DNase, RNase and Pyrogen free. The highly smooth surface is hydrophobic to provide low liquid retention, increased accuracy and repeatability. Inner radial rings enable an airtight grip on the tip cone. Autoclavable at 121°C and 15 psi for 30 minutes.

Item No.	Capacity (µl)	Color	Quantity per case
P10117	0.5 - 10 Sterile	Natural	10 racks x 96 pcs (960 pcs)
P10111	2 - 200 Sterile	Yellow	10 racks x 96 pcs (960 pcs)
P10148	2 - 200 Sterile	Natural	10 racks x 96 pcs (960 pcs)
P10113	100 - 1000 Sterile	Blue	10 racks x 96 pcs (960 pcs)



NEW PRODUCT

Filter Pipette Tips

Protect against cross-contamination using these filter pipette tips. Filters are manufactured of 100% pure porous polyethylene, and designed to prevent liquids and aerosols from entering the body of the micropipette. Best suited for biological applications, these tips are non-cytotoxic, nonhemolytic, and have 99.9% Bacterial Aerosol Filtration Efficiency (BFE). Tips are manufactured from ultrapure USP Class VI certified, virgin polypropylene. DNase, RNase and Pyrogen free.

Item No.	Tip Size	Color	Qty per pack
P11005	2 - 200 µl, Bevelled, Graduated	Natural	1,000
P11007	100 - 1000 µl	Natural	500



NEW PRODUCT

Racked Filter Pipette Tips, Sterile

Protect against cross-contamination using these racked, sterile filter pipette tips. Filters are manufactured of 100% pure porous polyethylene with a hydrophobic design to prevent liquids and aerosols from entering the body of the micropipette. Best suited for biological applications, these tips are non-cytotoxic, non-hemolytic, and have 99.9% Bacterial Aerosol Filtration Efficiency (BFE). Sterile tips are manufactured from ultrapure USP Class VI certified, virgin polypropylene. DNase, RNase and Pyrogen free.

Packaged in racks of 96 with 10 racks in each case.

Item No.	Tip Size	Color	Qty per case
P11025	2 - 20 µl, Graduated	Natural	10 racks x 96 pcs (960 pcs)
P11033	2 - 200 µl, Graduated	Natural	10 racks x 96 pcs (960 pcs)
P11037	100 - 1000 µl	Natural	10 racks x 96 pcs (960 pcs)



Labware Pipettes

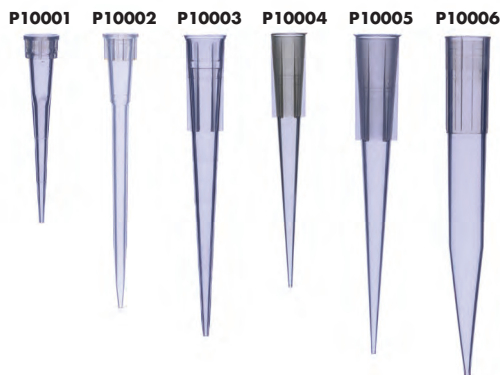

NEW PRODUCT

Transfer Pipettes, Disposable, PE

All-in-one pipettes are molded from unbreakable translucent polyethylene. Can be sealed and refrigerated.

Item No.	Capacity (ml)	Overall Length (mm)	Stem Length (mm)	Qty per pack
F1016-5	3.5	156	112	500
F1016-9-PK/100	2.0	138	102	100
F1016-7-PK/100	5.0	155	110	100

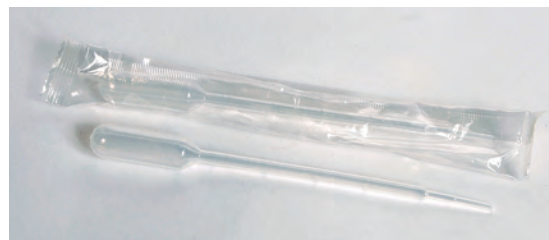

Micropipette Tips, Low Retention, PP

Use these tips to reduce sample retention for precision. Retention level is 10 times lesser with viscous samples than standard pipette tips. Highly homogenous surface is free of defects, preventing non-specific binding. Manufactured from ultrapure USP Class VI certified, virgin polypropylene. DNase, RNase and Pyrogen free.

Item No.	Tip Size	Color	Quantity per pack
P10001	0.2 - 10 µl Graduated	Natural	1,000
P10002	0.2 - 10 µl Extended, Graduated	Natural	1,000
P10003	2 - 200 µl, Bevelled, Graduated	Natural	1,000
P10004	2 - 200 µl, Ultra Point Tip Orifice	Natural	1,000
P10005	2 - 300 µl Graduated	Natural	1,000
P10006	100 - 1000 µl	Natural	500



Pipette Starter Kit

This custom kit contains three pipettes, plus accessories, at an economical price.

Contents:

- Variable Volume Micropipette, 2-20 µl (PVV-20) 1
- Variable Volume Micropipette, 2-200 µl (PVV-20) 1
- Variable Volume Micropipette, 100-1000 µl (PVV-1000) 1
- Replacement Micropipette Tips, 200 µl, pk/1000 (T200UL-Y) 1
- Replacement Micropipette Tips, 1000 µl, pk/500 (T1000UL-B) 1
- A guide to pipetting 1

Item No.	Description
PVVKIT	Pipette Starter Kit

Pasteur Pipettes, LDPE

Non-toxic all-in-one pipettes are molded from unbreakable translucent low-density polyethylene. Can be sealed and refrigerated. Available in sterile and non-sterile versions. Sterile pipettes are individually wrapped.

Item No.	Capacity (ml)	Length (mm)	Quantity per pack
P31201	1.0	150	500
P31202	1.0 (Sterile)	150	500
P31205	3.0	155	500
P31206	3.0 (Sterile)	155	500



Empty Micro Tip Boxes, PP

Empty micro tip boxes contain 96 tip holes, spaced uniformly so they can be used with a multi-channel micropipette. Includes a transparent top cover. Autoclavable.

Item No.	Tip Capacity (µl)	Places	L x W x H (mm)	Quantity per pack
P20102	2-200	96	126 x 93 x 70	6
P20103	200-1000	96	143 x 100 x 88	6



Pipette Stand, Vertical, 28-Place, PP

Polypropylene, non-corrosive pipette stand can hold up to 28 pipettes. The heavy base is 9" in diameter and the polypropylene coated square rod is 15" high. The top disc has holes for supporting the pipettes while the lower disc has pilot holes where pipette tips rest and liquids can drain down to the base. Distance between the discs can be adjusted to accommodate various pipette lengths.

Item No.	Description	Quantity per pack
79102	Pipette Stand, Vertical, 28-Place, PP	1



Pipette Stand, Rotary, 94-Place, PP

Molded in polypropylene, this non-corrosive pipette stand holds up to 94 pipettes and can be rotated for convenient selection of any pipette. Central vertical axis measures 19" in height. The lower rotating disc measures 9" in diameter and has four concentric troughs that align with the upper disc. This stand can be easily disassembled and reassembled.

Item No.	Description	Quantity per pack
79103	Pipette Stand, Rotary, 94-Place, PP	1



Pipette Stand, Horizontal, 12-Place, PP

Polypropylene pipette stand can hold up to 12 pipettes in a horizontal position. Autoclavable. Stand is constructed with three polypropylene coated metal rods for extra weight and stability. Can be easily disassembled and reassembled.

Item No.	Description	Quantity per pack
79101	Pipette Stand, Horizontal, 12-Place, PP	6



NEW PRODUCT

Pipette/Instrument Organizer Tray, PP

Designed for organizing pipettes or other lab instruments, our pipette tray is designed to fit large drawers, refrigerators and bench tops. Tray features 4 deep columns (approx. 3/4" deep) and is recommended for 1 to 10ml pipettes.

Dimensions are 16" x 12" x 1" and is autoclavable. Molded in polypropylene and features 1/8" thick walls.

Item No.	Description
PPT004	Pipette/Instrument Organizer Tray, PP

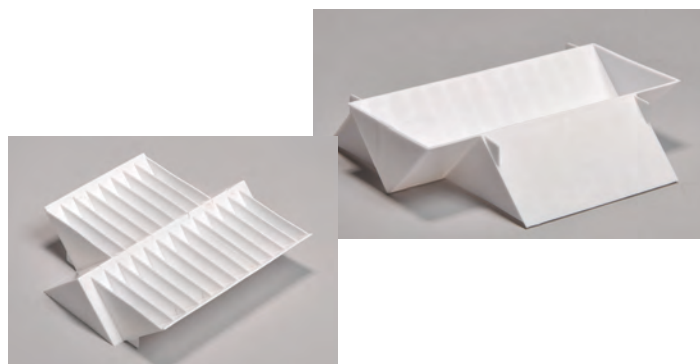

Reversible Reagent Reservoir, PP

This versatile polypropylene reservoir is useful for single and multichannel micropipettes. Positioned one way, it provides a 50ml reservoir for use with a single channel micropipette. Flipped over, it provides a numbered reservoir with eight separate 5ml reagent channels, and a numbered reservoir with twelve separate 5ml reagent channels. Autoclavable. Sold as a pack of 6.

Item No.	Description
79131	Reversible Reagent Reservoir, PP, pack of 6



Reagent Reservoir, PP

For use with micropipettes. Total capacity of 75ml. Includes graduation marks at 10, 30 and 60ml levels. Autoclavable. Sold as a pack of 12.

Item No.	Description
79121	Reagent Reservoir, PP, pack of 12



Labware Racks



Safety Goggles Box, Acrylic

Store goggles, glasses, or other small lab products using this clear acrylic box. It can be used on a desktop or can be mounted on a wall. Includes a lid to keep the box free of dust or contamination. Available in two sizes.

Item No.	L x W x H (cm)	Size	Quantity per pack
P70106	23 x 16 x 18	Small	1
P70107	23 x 16 x 25	Large	1



Parafilm M® Dispenser, Acrylic

Durable acrylic dispenser is ideal for storing, dispensing and cutting Parafilm M® tape and labels. Holds 2" or 4" rolls and includes a sharp, serrated blade for easy cutting. Lid opens for quick loading of rolls. Parafilm M not included.

Item No.	Capacity (inch)	L x W x H (mm)	Quantity per pack
P70401	2 and 4	180 x 120 x 160	1

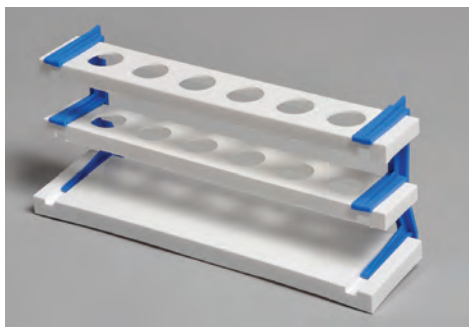

Nessler Cylinder Racks, 6-Tube, PP

Polypropylene rack is designed to hold six Nessler cylinders. Flat lower deck is white to provide a reflective surface. Chemical and corrosion resistant rack can be autoclaved at 121°C (250°F).

Item No.	Description
76101	Nessler Cylinder Rack for 50ml cylinders, PP
76102	Nessler Cylinder Rack for 100ml cylinders, PP

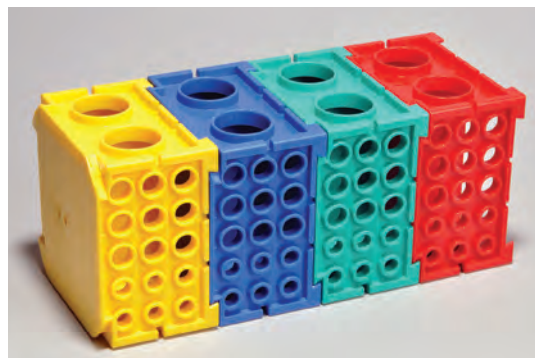

Rotator Workstation, PP

Organize various sized tubes using the Rotator workstation. Racks can be joined together using the unique rotate and lock design. Add as many racks as you need. Racks can withstand temperatures of -80°C to 121°C and are autoclavable. Built-in ridges enable easy drainage of liquids.

Rotator workstations hold the following products:

Tube Diameter	Number per unit
50 ml Centrifuge Tubes	2 per unit
15 ml Centrifuge Tubes	8 per unit
1.5ml or 2.0ml Microcentrifuge Tubes	9 per unit
0.5ml Microcentrifuge Tubes	6 per unit
PCR plates (unskirted or semi-skirted 96 well)	1 per 2 units put together
PCR 8-tube strips	6 per unit
PCR 12-tube strips	8 per 2 unit
PCR 0.2ml tubes	48 per unit

Item No.	L x W x H (mm)	Quantity per pack
P20208	108 x 68 x 108	4 (one each Blue, Green, Yellow and Red)

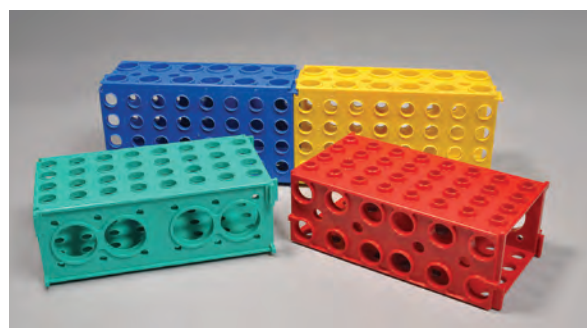

Multi Combination Racks, PP

Organize various sized tubes and vials. Racks can withstand temperatures of -80°C to 121°C and are autoclavable.

Multi Combination Racks hold the following products:

Tube Diameter	Number per unit
50 ml Centrifuge Tubes	4 per unit
15 ml Centrifuge Tubes	12 per unit
1.5ml or 2.0ml Microcentrifuge Tubes	32 per unit
0.5ml Microcentrifuge Tubes	32 per unit
RIA Vial / Plastic Test Tube 12 x 75mm	32 per unit

Item No.	L x W x H (mm)	Quantity per pack
P20209	175 x 90 x 65	4 (one each Blue, Green, Yellow and Red)



Test Tube Rack Set, Plastic Tubes

This set contains twelve 15ml screw top graduated plastic tubes and a brightly colored two tiered polypropylene test tube rack.

Item No.	Description
TTRSET-P	Test Tube Rack with 15ml Plastic Tubes



Test Tube Rack, 12-Tube, Unassembled, PP

Sturdy polypropylene rack will hold 12 test tubes up to 20mm in diameter. Easy to assemble, and chemical resistant.

Item No.	Description
TTHP03	Test Tube Rack, 12-Tube, Unassembled, PP



Test Tube Rack Set, Glass Tubes

This set contains twelve 24ml glass test tubes with rubber stoppers, and a brightly colored two tiered polypropylene test tube rack.

Item No.	Description
TTRSET	Test Tube Rack with 24ml Glass Tubes and Rubber Stoppers



Test Tube Racks, One-Piece, PP

One-piece molded racks have a three-tier grid design. Polypropylene construction provides good chemical and thermal resistance. Autoclavable. Racks feature a 3/4" x 2-3/4" labeling area on two sides. Open design allows easy viewing of contents from all sides.

Available in sizes that hold 13mm or 16mm tubes. Both racks feature a 6 x 6 array of holes.

Item No.	For tubes up to / No. of places	Quantity per pack
77906	13mm / 36 tubes	4
77907	16mm / 36 tubes	4

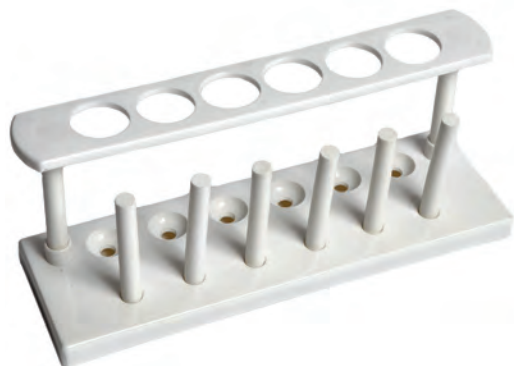

Test Tube Rack, Plastic, 6-Tube, Unassembled

This polyethylene rack will hold six test tubes, and has six drying pins. Sides are fully open for clear viewing. Rack has six 25mm holes and requires assembly.

Item No.	Description
TTHP02	Test Tube Rack, Plastic, 6-Tube, Unassembled

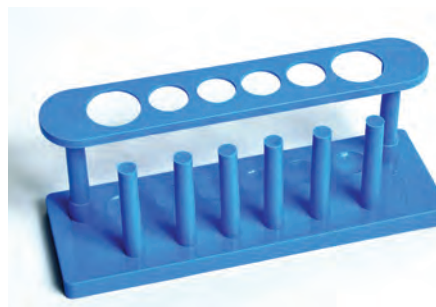

Test Tube Rack, Plastic, 6-Tube

This polyethylene rack will hold six test tubes, and has six drying pins. Sides are fully open for clear viewing. Rack has two 30mm and four 20mm holes, and is pre-assembled.

Item No.	Description
TTHP01	Test Tube Rack, Plastic, 6-Tube

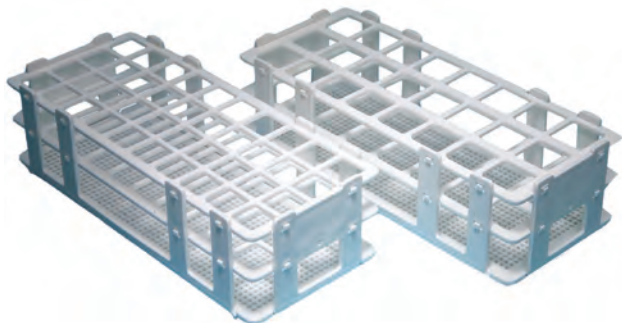

77707

Test Tube Racks, Wet/Dry, PP

Economical yet very durable racks that are submersible, autoclavable, and easily stack when empty. Made from a special blend of polypropylene (PP) that makes them sink in a water bath and maintain their stability even in agitated water. The top tier features an alpha-numeric grid reference. Available in white, but can be special ordered in various colors.

Item No.	For tubes up to / No. of places	Quantity per pack
77901	13mm / 90 tubes	6
77902	16mm / 60 tubes	6
77903	20mm / 40 tubes	6
77904	25mm / 24 tubes	6
77905	30mm / 21 tubes	6



77712



77714



Test Tube Rack, Cube, PP

A sturdy one-piece molded polypropylene rack. All four sides can be used interchangeably for 12mm through 25mm diameter tubes. Rack features a total of 88 spaces on its four sides.

Tube Diameter	Number per unit
50ml Tubes	8
20ml Tubes	20
15ml Tubes	24
12ml Tubes	40

Item No.	Description
76001	Plastic Test Tube Rack, Cube, PP



77718

Test Tube Racks, PP, 3-Tier

Polypropylene racks with a three-tier design provide a clear view of the tube contents and convenient insertion and removal of tubes.

Item No.	For tubes up to / No. of places	Quantity per pack
77706	13mm / 31 tubes	2
77707	16mm / 31 tubes	2
77708	20mm / 20 tubes	2
77709	25mm / 12 tubes	2
77710	25mm / 18 tubes	2
77711	32mm / 12 tubes	2
77712	25mm / 36 tubes	2
77714	13mm / 18 tubes	4
77715	15mm / 18 tubes	4
77716	18mm / 12 tubes	4
77717	13mm / 62 tubes	2
77718	16mm / 62 tubes	2
77719	20mm / 40 tubes	2



Test Tube Rack, 13-Tube, Wooden

Two-tier rack with thirteen 25mm holes, and six drying pins. Solid hardwood construction. Polished to minimize damage from spills.

Item No.	Description
TTHW04	Test Tube Rack, 13-Tube, Wooden

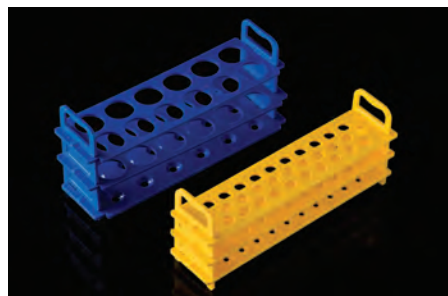

Test Tube Racks, PC

Polycarbonate racks feature ergonomic design for easy handling. Provides good chemical resistance. Autoclavable and withstands temperatures from -135° to 135°C. Includes molded-in numbers and letters for easy identification of test tubes.

Item No.	Tubes (mm)	Places	Color	L x W x H (mm)	Qty per pack
P20708B	16	31	Blue	275 x 65 x 110	4
P20708W	16	31	White	275 x 65 x 110	4
P20708Y	16	31	Yellow	275 x 65 x 110	4

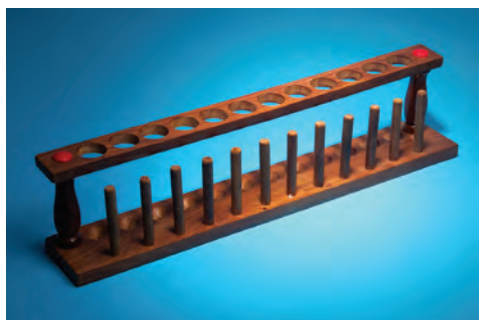

Test Tube Rack, 12-Tube, Wooden

Twelve 25mm holes, twelve drying pins, with a 1/2" thick base. Solid hardwood construction. Polished to minimize damage from spills.

Item No.	Description
TTHW03	Test Tube Rack, Wooden, 12-Tube



Test Tube Rack, Round, 24-Tube, Plastic

Good quality round test tube rack will hold 24 tubes up to 20mm in diameter. Solid high-impact plastic construction. Rack is 145mm in diameter and 70mm high, and features a perforated bottom. Shipped pre-assembled.

Item No.	Description
TTHP05	Test Tube Rack, Round, 24-Tube, Plastic

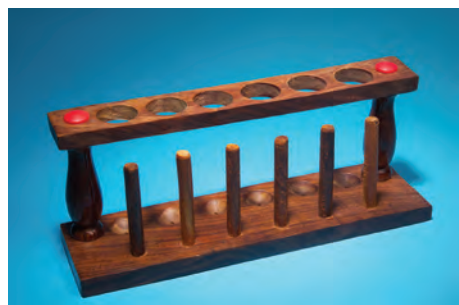

Test Tube Rack, 6-Tube, Wooden

Six 25mm holes, six drying pins, with a 1/2" thick base. Solid hardwood construction. Polished to minimize damage from spills.

Item No.	Description
TTHW01	Test Tube Rack, Wooden, 6-Tube

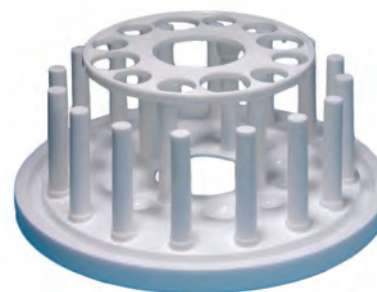

Test Tube Rack, Round, 12-Tube, PP

This circular 12 place polypropylene test tube stand has four 25mm diameter holes and eight 19mm diameter holes. The base has matching wells and 16 drying pins surrounded by a trough to catch drippings. Pre-assembled.

Item No.	Description
77704	Test Tube Rack, Round, 12-Tube, PP



Test Tube Rack, Wire, Epoxy-Coated

Heavy wire test tube rack includes a durable epoxy coating. Holds up to 36 tubes.



Item No.	Description
TTWE01	Test Tube Rack, Wire, Epoxy-Coated

Test Tube Rack, Stainless Steel

Sturdy Z-shaped rack made from a single sheet of heavy gauge 304 stainless steel. Rack features 25 wells in five rows, for tubes up to 16mm in diameter. Polished, smooth surface facilitates easy cleaning and labeling.



Item No.	Description
TTRSS25	Test Tube Rack, Stainless Steel

Test Tube Baskets, PP

These test tube baskets are made of polypropylene. Autoclavable, unbreakable and non-corrosive baskets are ideal for rinsing and draining glassware. They are also useful for storage of test tubes or culture tubes during sterilization or incubation.



Item No.	Description	Quantity per pack
78101	Test Tube Basket, 140 x 120 x 110mm	6
78102	Test Tube Basket, 160 x 160 x 160mm	6

Draining Tray, PP

This polypropylene basket with wide net-like structure on all sides is useful for post-wash draining of laboratory apparatus. Autoclavable.



Item No.	Description	Quantity per pack
78103	Draining Tray, PP, 16" x 16" x 4"	6

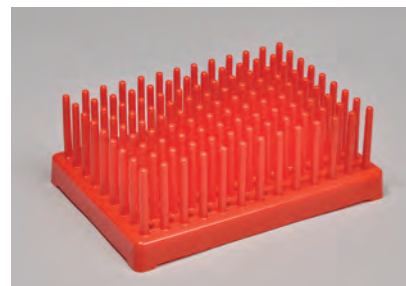

Test Tube Drying Racks, PP

These polypropylene racks can conveniently hold inverted tubes for drying and to minimize collection of airborne contaminants. Racks can also be used to hold and dry electrophoresis and chromatography plates. Autoclavable.

The 96 place rack features an 8 x 12 array of pegs that hold tubes up to 13mm in diameter. The 50 place rack features a 5 x 10 array of pegs that hold tubes up to 16mm in diameter.

Item No.	Description	Quantity per pack
77851	96 places for up to 13mm tubes	6
77852	50 places for up to 16mm tubes	6



Drying / Draining Rack

The ABS plastic draining rack provides an excellent option for post-wash draining of tubes and bottles. Rack stands 20" tall x 14" wide. The back plate has 20 holes into which 5" pegs are tightened with the help of screw-nuts. Also includes two holes so the rack can be mounted on a wall. The bottom of the rack features a wastewater tray and drain.

Item No.	Description	Quantity per pack
81741	Drying / Draining Rack, 20 Place	1



SCPLG52



SCPSM05

Laboratory Scoops with Handles, Stainless Steel

These laboratory scoops are made from high quality stainless steel and are available in two sizes: 5 oz. and 52 oz.

Item No.	Description
SCPSM05	Laboratory Scoop with Handle, Stainless Steel, 5 oz.
SCPLG52	Laboratory Scoop with Handle, Stainless Steel, 52 oz.



Laboratory Scoops, PP

These sturdy polypropylene scoops are available in a variety of sizes and as a complete set of seven scoops. Capacities are molded into the top of each scoop for easy reference. The PP material is autoclavable and will not rust or corrode.

Item No.	Capacity (ml)	Quantity per pack
81253	10	12
81254	25	12
81255	50	12
81256	100	12
81257	250	12
81258	500	6
81259	1000	6
81260	Set of 7 Scoops (one of each size)	



Laboratory Scoop, Stainless Steel

Stainless steel scoop with one pointed end for handling small amounts of chemicals. Length 6-1/2" (16.5cm). Also available with 5" long hardwood handle.

Item No.	Description
LSCSS6	Laboratory Scoop, Stainless Steel
LSHND1	Hardwood Handle for Laboratory Scoop
LSCSET	Laboratory Scoop and Hardwood Handle Set



Spatulas, Stainless Steel with Wooden Handles

Flexible stainless steel blade with rounded end, mounted in a polished wood handle.

Item No.	Description
SSSW03	Spatula with Wooden Handle, 3" Blade
SSSW04	Spatula with Wooden Handle, 4" Blade
SSSW05	Spatula with Wooden Handle, 5" Blade
SSSW06	Spatula with Wooden Handle, 6" Blade
SSSW08	Spatula with Wooden Handle, 8" Blade



Spatulas, Stainless Steel

Stainless steel spatulas, available in various styles and sizes.

Item No.	Description	Quantity per pack
SSFB04	Spatula, 4" (10cm) long, one end flat, one end bent	10
SSFB06	Spatula, 6" (15cm) long, one end flat, one end bent	10
SSFB08	Spatula, 8" (20cm) long, one end flat, one end bent	10
SSFF05	Spatula, 5" (12.5cm) long, both ends flat	10
SSFF08	Spatula, 8" (20cm) long, both ends flat	10
SSFT06	Spatula, 6" (15cm) long, one end flat, one end tapered	10



Spatulas, Stainless Steel, Both Ends Flat

Stainless steel spatulas with both ends flat.

Item No.	Description	Quantity per pack
SSSS04	Spatula, Both Ends Flat, 4" (10cm) long	10
SSSS06	Spatula, Both Ends Flat, 6" (15cm) long	10
SSSS08	Spatula, Both Ends Flat, 8" (20cm) long	10

Spatulas, Stainless Steel, Flat and Spoon

Stainless steel spatulas with one flat end and one spoon end.

Item No.	Description	Quantity per pack
SSSP04	Spatula, One Flat End, One Spoon End, 4" (10cm) long	10
SSSP06	Spatula, One Flat End, One Spoon End, 6" (15cm) long	10
SSSP08	Spatula, One Flat End, One Spoon End, 8" (20cm) long	10



Spatulas, Set of 6

Set of six of our most popular spoons and spatulas for the laboratory. Includes one each: SSSW04 (4" blade stainless steel spatula mounted on a hardwood handle), 81301 (6" polypropylene spatula, one end flat, one end spoon), SSFB06 (6" stainless steel spatula, one end bent, one end flat), SSSP06 (6" stainless steel spatula, one end flat, one end spoon), SSSS06 (6" stainless steel spatula, both ends flat), and SSFT06 (6" stainless steel spatula, one end flat, one end tapered).

Item No.	Description
SPATST6	Spatulas, Set of 6



NEW PRODUCT

Spatulas, Soft-Grip

Soft, silicone grip provides improved comfort and handling. Blade is constructed of stainless steel with a flexible, rounded end. Handle is manufactured of polypropylene and layered with a silicone grip. Handle dimensions are 4-1/8" L x 1" W x 1/2" H. Latex-free. Autoclavable.

Item No.	Overall Length	Blade Length	Blade Width	Qty per pack
SSSG03	7.25"	3"	3/4"	1
SSSG04	8.25"	4"	3/4"	1
SSSG05	9.25"	5"	3/4"	1
SSSG06	10.25"	6"	1"	1
SSSG08	12.25"	8"	1"	1



Labware Spatulas



Spatulas, PP, Flat and Spoon

Molded in polypropylene, spatulas feature a spoon on one side. Available in 6" or 8" lengths.

Item No.	Description	Quantity per pack
81301	Spatula, PP, Flat and Spoon, 6" long	12
81302	Spatula, PP, Flat and Spoon, 8" long	12



Policeman / Spatula, PP

Multi-purpose tool made from polypropylene can be used as a stirrer or spatula. Measures 9.5" long with a diameter of 1/4".

Item No.	Description	Quantity per pack
81411	Policeman / Spatula, PP	12



Micro Spatula, Stainless Steel

Stainless steel micro spatula, 8" (20cm) long, one end flat and one end pointed.

Item No.	Description
SSFT08	Micro Spatula, Stainless Steel



Spatulas with Spoons, Porcelain

Glazed porcelain spatula with one flat end and one spoon end.

Item No.	Length (mm)	Capacity (ml)	Quantity per pack
JSS001	100	0.1	1
JSS003	125	0.3	1
JSS005	165	0.5	1
JSS010	198	1.2	1
JSS060	260	5.5	1



Spatula, Porcelain

Glazed porcelain spatula, with one long flat end, features a knob on the other end for easy grip. Measures 8" (20cm) long.

Item No.	Description	Quantity per pack
JST001	Spatula, Porcelain	1



Micro Spoon, Stainless Steel

Stainless steel micro spoon has an overall length of 23.5cm (9.25"), with one end spoon and one end flat.

Item No.	Description
SSFS09	Micro Spoon, Stainless Steel



Micro Spoon, Stainless Steel with Plastic Handle

Stainless steel micro spoon has an overall length of 16.5cm (6.5"), with one end round and one end plastic-coated for easy grip.

Item No.	Description
SSPP07	Micro Spoon, Stainless Steel with Plastic Handle



Labware Spot / Well Plates



Watch Glasses

Made from soda lime glass (1.8 mm thick), fine ground and flame polished edges.



Item No.	Diameter (mm)	Quantity per pack
WGB170-40	40	10
WGB170-50	50	10
WGB170-60	60	10
WGB170-70	70	10
WGB170-80	80	10
WGB170-90	90	10
WGB170-100	100	10
WGB170-125	125	10
WGB170-150	150	10
WGB170-200	200	10

Watch Glasses, Economy

Made from clear flint glass (1.8 to 2.0mm thick), fine ground and polished edges.

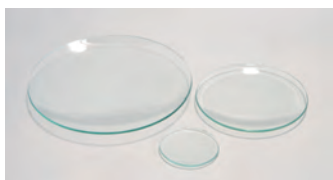

Item No.	Diameter (mm)	Quantity per pack
WGL025	25	12
WGL040	40	12
WGL050	50	12
WGL065	65	12
WGL075	75	12
WGL090	90	12
WGL100	100	12
WGL125	125	12
WGL150	150	12
WGL200	200	12
WGL250	250	12
WGL300	300	12

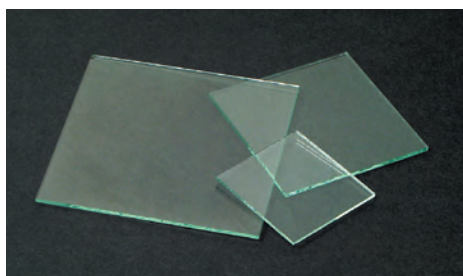

Glass Plates

Plates made of clear flint glass, 2mm thick, with ground polished edges. Useful for a variety of general laboratory applications including as a cover, mixing surface, etc.

Item No.	Description	Quantity per pack
GLP2X2	Glass Plate, 2" x 2"	12
GLP3X3	Glass Plate, 3" x 3"	12
GLP4X4	Glass Plate, 4" x 4"	12
GLP5X5	Glass Plate, 5" x 5"	12
GLP6X6	Glass Plate, 6" x 6"	12
GLP8X11	Glass Plate, 8" x 11"	1

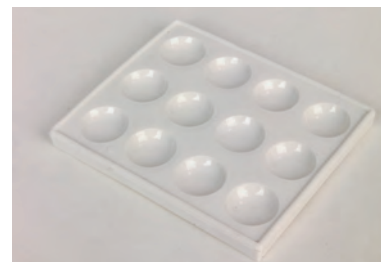

Spot Plate, 12 Cavity, Plastic

These economical white polystyrene plates have 12 depressions and are suitable for most applications where glass or porcelain plates are used. They are not recommended for strong solvents such as acetone or xylene. Each plate measures 112 x 92mm. Sold as a pack of 12.

Item No.	Description	Quantity per pack
SPPL12	Spot Plate, 12 Cavity, Plastic	12



Spot Plates, Porcelain

Color-reaction or spot plates, glazed except for bottom surface.

Item No.	Number of Wells	Length (mm)	Width (mm)	Quantity per pack
JSC003	3	90	29	1
JSC006	6	94	62	1
JSC012	12	115	88	1
JSC030	30	177	137	1

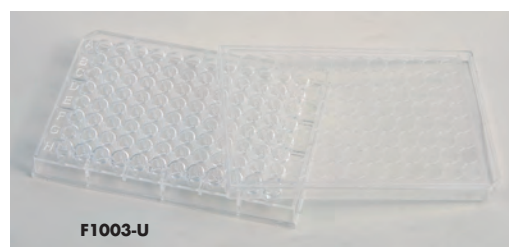

Well Plates, Clear Plastic

Clear polystyrene plate features deep uniform wells and include lids. Each well has an alpha-numeric marking. Non-sterile plates are individually wrapped in a plastic bag.

The 24-well plate measures 5" long x 3-1/4" wide x 7/8" high. Flat-bottomed wells are 5/8" deep and approximately 10mm in diameter.

The 96-well plate measures 5" long x 3-1/4" wide x 5/8" high. U-bottomed wells are 7/16" deep and approximately 6mm in diameter.

Item No.	Description	Quantity per pack
F1004	Well Plate, 24 Wells	10
F1003-U	Well Plate, 96 Wells	10



Support Stands with Rods, Stamped Steel

Stamped steel bases with black enamel finish. Includes a removable, zinc-plated steel rod. Bases and rods are also available individually.

Item No.	Base Size	Rod Length	Rod Diameter
SSB4X6	4" x 6"	18"	5/16"
SSB5X8	5" x 8"	20"	3/8"
SSB6X9	6" x 9"	24"	1/2"
SSB6X1	6" x 11"	36"	1/2"



Support Stands with Rods, Cast Iron

Heavy cast iron bases with black enamel finish. Includes a removable zinc-plated steel rod. Bases and rods are also available individually.

Item No.	Base Size	Rod Length	Rod Diameter
SSB4X6-CI	4" x 6"	18"	5/16"
SSB5X8-CI	5" x 8"	20"	3/8"
SSB6X9-CI	6" x 9"	24"	1/2"
SSB6X1-CI	6" x 11"	36"	1/2"

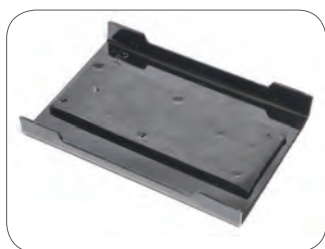

Heavy support stand includes a reinforcing steel plate that provides extra weight.



Heavy Support Stands with Rods, Stamped Steel

Heavy stamped steel bases with black enamel finish include a steel plate mounted underneath, which makes them about 50% heavier than regular stamped steel bases. The steel plate also facilitates a sturdier threading of the rod into the base.

Includes a removable, zinc-plated steel rod. Bases and rods are also available individually.

Item No.	Base Size	Rod Length	Rod Diameter
SSB4X6-H	4" x 6"	18"	5/16"
SSB5X8-H	5" x 8"	20"	3/8"
SSB6X9-H	6" x 9"	24"	1/2"
SSB6X1-H	6" x 11"	36"	1/2"

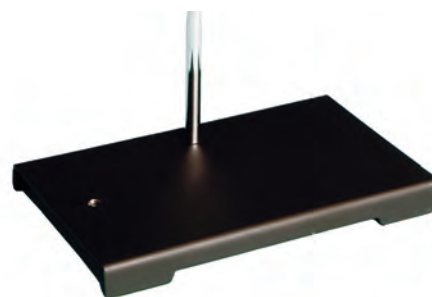

Two-Hole Support Stands with Rods, Stamped Steel

Stamped steel bases with black enamel finish feature two tapped holes. Hole at center of the shorter side is for standard ring stand use. Hole at center of the longer side is for applications such as titrations, specific gravity determinations, etc.

Includes a removable zinc-plated steel rod. Bases and rods are also available individually.

Item No.	Base Size	Rod Length	Rod Diameter
SSB4X6-H2	4" x 6"	18"	5/16"
SSB5X8-H2	5" x 8"	20"	3/8"
SSB6X9-H2	6" x 9"	24"	1/2"
SSB6X1-H2	6" x 11"	36"	1/2"



Triangular Support Stands with Rods, Cast Iron

Heavy cast iron triangular bases with black enamel finish. Includes a removable zinc-plated steel rod.

Item No.	Base Size	Rod Length	Rod Diameter
TSR318	3"	18"	5/16"
TSR420	4"	20"	3/8"
TSR524	5"	24"	1/2"
TSR636	6"	36"	1/2"

Support Stand and Ring Sets

Each set contains a stamped steel base and a zinc-plated steel rod, along with 2, 3, 4, or 5 cast iron rings with boss head clamps.

Item No.	Base Size	Rod Length	Rod Diameter	Ring Size
SET462	4" x 6"	18"	5/16"	3", 4"
SET583	5" x 8"	20"	3/8"	3", 4", 5"
SET694	6" x 9"	24"	1/2"	3", 4", 5", 6"
SET615	6" x 11"	36"	1/2"	2", 3", 4", 5", 6"



NEW PRODUCT

Deluxe Support Stands with Adjustment Rod, Cast Iron

Cast iron bases with gray enamel finish. The base is 3mm thick with a welded plate on the mounting hole. This gives the support rod 10mm of screw support, which is three times thicker than other traditional stands. The support rod includes an 80mm long rod to provide more torque when securing the rod to the base plate. Includes a removable, zinc-plated steel rod.



80mm adjustment rod provides more torque when securing rod to base



Cast iron base with welded plate provides 10mm of screw support



Easily accessed adjustment rod lets users quickly tighten or loosen the rod in the base

Item No.	Base Size	Rod Length	Rod Diameter
SSB4X6-J	4" x 6"	18"	5/16"
SSB5X8-J	5" x 8"	20"	3/8"
SSB6X9-J	6" x 9"	24"	1/2"
SSB6X1-J	6" x 11"	36"	1/2"



Support Rings, Cast Iron

Cast iron, zinc-plated support ring with boss head clamp and thumbscrew. Distance from support to center of ring is 4-1/2" for all sizes.

Item No.	Description	Quantity per pack
SRCI02	Cast Iron Support Ring, 2" Diameter	5
SRCI03	Cast Iron Support Ring, 3" Diameter	5
SRCI04	Cast Iron Support Ring, 4" Diameter	5
SRCI05	Cast Iron Support Ring, 5" Diameter	5
SRCI06	Cast Iron Support Ring, 6" Diameter	5
SRCI07	Cast Iron Support Ring, 7" Diameter	5



Support Rings, Steel Rod

Steel rod, zinc-plated support ring with attached boss head clamp and thumbscrew. Distance from support to center of ring is 4-1/2" for all sizes.

Item No.	Description	Quantity per pack
SRSR02	Steel Rod Support Ring, 2" Diameter	5
SRSR03	Steel Rod Support Ring, 3" Diameter	5
SRSR04	Steel Rod Support Ring, 4" Diameter	5
SRSR05	Steel Rod Support Ring, 5" Diameter	5
SRSR06	Steel Rod Support Ring, 6" Diameter	5
SRSR07	Steel Rod Support Ring, 7" Diameter	5



Extension Support Rings

Steel rod, zinc-plated extension support rings. Rod diameter 5/16", overall length 12" for all sizes.

Item No.	Ring Diameter	Quantity per pack
SRSE02	Extension Support Ring, 2" Diameter	1
SRSE03	Extension Support Ring, 3" Diameter	1
SRSE04	Extension Support Ring, 4" Diameter	1
SRSE05	Extension Support Ring, 5" Diameter	1
SRSE06	Extension Support Ring, 6" Diameter	1



A-Base and Rod, Cast Iron

The A-shaped base is made of rugged cast iron and is designed for extra stability. It has 8" long legs with a black enamel finish. The 5" to 7-1/2" opening between the legs is designed for positioning items near the support rod. Includes a removable zinc-plated steel rod that is 24" long and 1/2" in diameter.

Item No.	Description
SBA724	A-Base and Rod, Cast Iron



Tripod Stands with Concentric Rings, Cast Iron

Removable concentric rings provide an adjustable worksurface for various applications. Available with three or four cast iron rings with black enamel finish. Detachable zinc plated legs are interchangeable for use with various sizes of rings. Rings and legs are also available individually.

Item No.	Ring O.D.	Height
TCR6X9	3.5", 4.75", 6.5"	9"
TCR8X9	3.5", 4.75", 6.5", 8"	9"



Tripod Stands, Cast Iron

Cast iron ring with black enamel finish. Detachable zinc plated legs are interchangeable for use with various sizes of rings. Rings and legs are also available individually.

Item No.	Ring O.D.	Height
TRS3X6	3.5"	6"
TRS3X9	3.5"	9"
TRS5X8-S	5"	9"
TRS5X8	5"	8"
TRS6X9	6"	9"



SSP6X6



SSP7X13

Support Stands with Rods, Porcelain

Heavy porcelain bases with glazed finish to prevent chemicals from seeping into the base. Base includes rubber feet to ensure the base does not slide or damage bench surface. Hole for rod is located in the center of the base. Includes a removable aluminum support rod. Stainless steel support rod is available separately.

Item No.	Base Size	Rod Length	Rod Diameter
SSP6X6	6" x 6"	20"	3/8"
SSP7X13	7" x 13"	24"	1/2"

Support Stands with Rods, Plastic

Molded polystyrene support stands are ideal for use in applications that require non-corrosive worksurfaces. Heavy, weighted base provides stability similar to metal versions. The removable steel rod is coated with polypropylene to make it non-corrosive.



54102

Item No.	Base Size	Rod Length	Rod Diameter
54101	6" x 9" with side hole	30"	1/2"
54102	8" x 12" with center hole	30"	1/2"
54103	8" x 12" with side hole	30"	1/2"

Laboratory Jack with Platform and Rod



Laboratory support jack is constructed of painted aluminum and stainless steel. The scissor jack design enables height adjustment with a simple turn of the knob. Sturdy design can support loads up to 20kg.

Lab jack platform measures 4.5" x 5.5". Platform height can be vertically adjusted from closed position of 2.75" up to 10.5".

Set includes a removable 8" x 8" platform that attaches to the lab jack using the included 18" long, 1/2" diameter support rod.

Item No.	Description
LBJSET	Laboratory Jack with Platform and Rod



LBJK44 closed



LBJK66 closed



LBJK88 closed

Laboratory Jacks

Laboratory support jacks are constructed of painted aluminum and stainless steel. The scissor jack design enables height adjustment with a simple turn of the knob.

LBJK44 has a 4" x 4" platform that can be vertically adjusted from a closed position of 2.5" up to 6". Maximum load capacity is 10kg.

LBJK66 has a 6" x 6" platform that can be vertically adjusted from a closed position of 3" up to 10.5". Maximum load capacity is 20kg.

LBJK88 has a 8" x 8" platform that can be vertically adjusted from a closed position of 2.5" up to 11.75". Maximum load capacity is 25kg.

Item No.	Description
LBJK44	Laboratory Jack, 4" x 4" Platform
LBJK66	Laboratory Jack, 6" x 6" Platform
LBJK88	Laboratory Jack, 8" x 8" Platform



Scan to view demonstration video



LBJK01 closed

Laboratory Jack

Laboratory support jack is constructed of painted aluminum and stainless steel. The scissor jack design enables height adjustment with a simple turn of the knob. Sturdy design can support loads up to 20kg.

Lab jack platform measures 4.5" x 5.5" and features pre-drilled holes for attaching a support rod. Platform height can be vertically adjusted from closed position of 2.75" up to 10.5".

Item No.	Description
LBJK01	Laboratory Jack



Lattice Lab System, Set #1



Setup with foot plates secured to a bench.
Two-dimensional lattices can be assembled in units of 24" x 24" with the crossbars horizontal or vertical. The set allows construction of up to two 24" x 24" sections with one crossbar each.

The Lattice Lab System is a lightweight set of aluminum support rods and clamps that allows a wide range of lab apparatus to be assembled and securely supported. Assembly is easy and requires only a screwdriver. Support rods are made of hard aluminum and foot plates and hook connectors are made of cast alloy.

Contents:

Foot Plate, 2-5/16" diameter	4
Set Screw for Foot Plate	4
Anchoring Screw for Foot Plate	12
Hook Connector with Thumbscrew	22
Support Rod, 2" long, 1/2" diameter	8
Support Rod, 18" long, 1/2" diameter	2
Support Rod, 24" long, 1/2" diameter	8

Item No.	Description
LLS001	Lattice Lab System, Set #1



Sections can be added at any angle.
This can provide limited stability without securing all of the foot plates to the bench. Add heavy apparatus inside the angle of the sections for stability.



Scan to view demonstration video



Create a portable 24" x 24" lattice.
Assemble it using the two 18" support rods with 2" support rods and the foot plates to form a secure base. More 2" rods and two 24" rods form a strong angle brace to maintain the lattice upright.

Lattice Lab System, Set #2

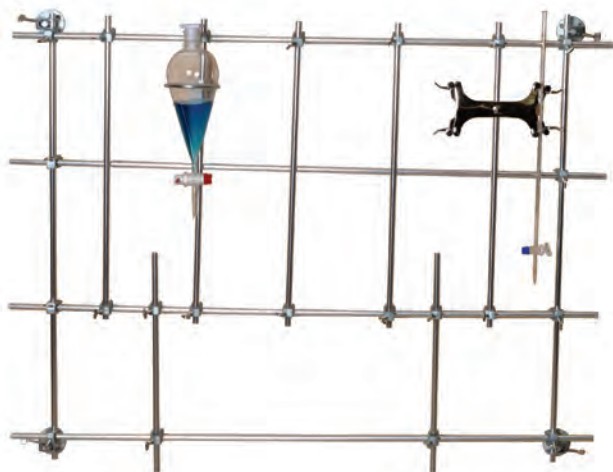

Five different rod lengths.
Construct a wide variety of lattice structures using this assortment that includes 2", 18", 24", 36" and 48" long rods.

This Lattice Lab System features an assortment of aluminum rods from 18" to 48" long. Assembly is easy and requires only a screwdriver. Support rods are made of hard aluminum and foot plates and hook connectors are made of cast alloy.

Contents:

Foot Plate, 2-5/16" diameter	4
Set Screw for Foot Plate	4
Anchoring Screw for Foot Plate	12
Hook Connector with Thumbscrew	26
Support Rod, 2" long, 1/2" diameter	8
Support Rod, 18" long, 1/2" diameter	2
Support Rod, 24" long, 1/2" diameter	5
Support Rod, 36" long, 1/2" diameter	2
Support Rod, 48" long, 1/2" diameter	4

Item No.	Description
LLS002	Lattice Lab System, Set #2



Lattice Lab System, Set #3

This Lattice Lab System features an assortment of aluminum rods, including 10 rods that are 48" long. Assembly is easy and requires only a screwdriver. Support rods are made of hard aluminum and foot plates and hook connectors are made of cast alloy.

Contents:

Foot Plate, 2-5/16" diameter	6
Set Screw for Foot Plate	6
Anchoring Screw for Foot Plate	18
Hook Connector with Thumbscrew	42
Support Rod, 2" long, 1/2" diameter	10
Support Rod, 18" long, 1/2" diameter	3
Support Rod, 36" long, 1/2" diameter	2
Support Rod, 48" long, 1/2" diameter	10



Includes 10 rods of 48" length.

This set features a large quantity of 48" rods for use in labs that require a large setup.

Item No.	Description
LLS003	Lattice Lab System, Set #3

Lattice Lab System, Set #4



Includes rods up to 72" long.

Extra-long 72" rods can be positioned horizontally or vertically.

Contents:

Foot Plate, 2-5/16" diameter	8
Set Screw for Foot Plate	8
Anchoring Screw for Foot Plate	24
Hook Connector with Thumbscrew	49
Support Rod, 2" long, 1/2" diameter	6
Support Rod, 12" long, 1/2" diameter	6
Support Rod, 24" long, 1/2" diameter	2
Support Rod, 48" long, 1/2" diameter	7
Support Rod, 72" long, 1/2" diameter	5

This Lattice Lab System set features aluminum rods up to 72" long. Assembly is easy and requires only a screwdriver. Support rods are made of hard aluminum and foot plates and hook connectors are made of cast alloy.

Item No.	Description
LLS004	Lattice Lab System, Set #4

Lattice Lab Rod Connector



This aluminum connector is used to attach two aluminum rods together. 12.9mm inner diameter. Includes two set screws and an Allen key.

Item No.	Description
LLSRC2	Lattice Lab Rod Connector

Lattice Lab Accessories

Components from Lattice Lab Sets are available individually so sets can be expanded to accommodate customized needs.

Item No.	Description
LLSCLMP	Hook Connector, Aluminum
LLSFPS	Foot Plate
LLSR02	Aluminum Rod, 2" long
LLSR24	Aluminum Rod, 24" long
LLSR36	Aluminum Rod, 36" long
LLSR48	Aluminum Rod, 48" long
LLSR72	Aluminum Rod, 72" long



Hook Connector connects two 1/2" diameter support rods at right angles with a single thumbscrew.



Foot plates accept 1/2" diameter support rods. Three 3/16" countersunk holes allow the foot plate to be secured to a bench.



Set screw fits into foot plates to secure support rods.





Labware Stands



Two-Way Burner Stand

This stand is ideal for use with alcohol burners. The base is made from 3/16" stainless steel rod, with a plated steel mesh top. The stand can be used in either high (5") or low (4") position.

Item No.	Description
ABHL01	Two-Way Burner Stand



Alcohol Burner Stand

Made of steel wire, zinc plated. Stand has a heavy wire gauze top. Overall height is 5", to accommodate all sizes of burners. Also available with a ceramic center on wire gauze top.

Item No.	Description
ABSP05	Alcohol Burner Stand
ABSC05	Alcohol Burner Stand, with Ceramic Center

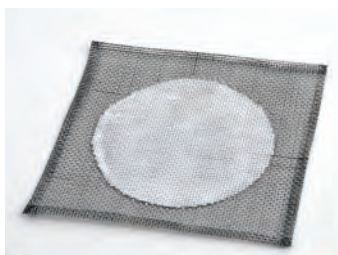

Wire Gauze with Ceramic Center

Iron wire gauze (24 SWG/10 Mesh) with ceramic coating at the center and folded edges. Contains no asbestos. Sold as packs of 10.

Item No.	Description	Quantity per pack
WGCC44	Wire Gauze with Ceramic Center, 4" x 4"	10
WGCC55	Wire Gauze with Ceramic Center, 5" x 5"	10
WGCC66	Wire Gauze with Ceramic Center, 6" x 6"	10



Wire Gauze, Plain

Iron wire gauze (24 SWG/10 Mesh) with folded edges. Sold as packs of 10.

Item No.	Description	Quantity per pack
WGPL44	Wire Gauze, Plain, 4" x 4"	10
WGPL55	Wire Gauze, Plain, 5" x 5"	10
WGPL66	Wire Gauze, Plain, 6" x 6"	10



GSLT01



GSFLT1-PK/5

Gas Lighter

Hooded lighter is safe, and economical. The hood traps gas, and protects the lighting file. Replacement flints are also available.

Item No.	Description
GSLT01	Gas Lighter
GSFLT1-PK/5	Replacement flints, pack of 5



Clay Pipe Triangles

Good quality clay pipe mounted on heavy gauge twisted galvanized steel wire.

Item No.	Description
CPT015	Clay Pipe Triangle, 1.5" side length
CPT020	Clay Pipe Triangle, 2.0" side length
CPT025	Clay Pipe Triangle, 2.5" side length
CPT030	Clay Pipe Triangle, 3.0" side length



Labware Stirring Rods



Micropipette Stand, Modular, PP

Ideal for holding a micropipette conveniently at a workstation, this polypropylene stand is designed for easy access. The modular shape enables multiple stands to be joined together, so micropipettes of various capacities can be stored as a group.

Item No.	Description
MPSM01	Micropipette Stand, Modular, PP



Stirring Rods, Glass, One End Flat

Stirring rod made of soft flint glass, 12" long and 7mm in diameter, with one end flat for use as a spatula or policeman. Sold as a pack of 12.

Item No.	Description	Quantity per pack
GLROD12-PK/12	Glass Stirring Rod, One End Flat	12

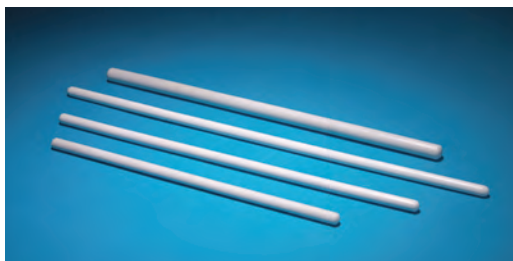

Stirring Rods, Plastic

Stirring rods made of polypropylene, with both ends rounded.

Item No.	Length / Diameter	Quantity per pack
81401	10" / 10mm	12
81405	8" / 7mm	12
81406	10" / 7mm	12
81407	12" / 7mm	12



Stirring Rods, Glass with Rubber Policeman

Rubber policeman attached to glass rod facilitates scraping and mixing. Stirring rods are made of soft flint glass, with both ends fire-polished and rounded. Policemen are made of natural rubber. Pre-assembled.

Item No.	Length / Diameter	Quantity per pack
GRPL05	5" / 3mm	12
GRPL06	6" / 5mm	12
GRPL08	8" / 5mm	12
GRPL10	10" / 6mm	12
GRPL12	12" / 10mm	12



Stirring Rods, Glass

Stirring rods are made of soft flint glass, with both ends fire-polished and rounded.

Item No.	Length / Diameter	Quantity per pack	Quantity per case
GSR005	5" / 3mm	12	144
GSR006	6" / 5mm	12	144
GSR008	8" / 5mm	12	144
GSR010	10" / 6mm	12	144
GSR012	12" / 10mm	12	144
GSR015	15" / 6mm	12	144



Rubber Policeman

Made of natural rubber. Ideal for scraping and mixing applications in the laboratory. Two different sizes are available, one for 5mm and 6mm diameter rods, and one for 10mm diameter rods. Sold as a pack of 12.

Item No.	Description	Quantity per pack
RHGSR1	Rubber Policeman, fits 5mm and 6mm diameter rods	12
RHGSR2	Rubber Policeman, fits 10mm diameter rods	12



Rubber Stoppers

These black stoppers are made of solid natural rubber that stays pliable over a long period of time. Ideal for use with non-aggressive or concentrated solutions. Low sulfur content. Withstand temperatures from -25 to 70°C (-13 to 158°F). Available in solid, one-hole, and two-hole versions. Each stopper has its size marked in raised figures. All stoppers are 25mm tall. Sold as one-pound bags.



Rubber stoppers are packaged in convenient one-pound bags.

*NEW SIZE

Item No. Solid	Item No. One-Hole	Item No. Two-Hole	Stopper Size	Approx. No. per Lb.	Top Diameter	Bottom Diameter	Hole Size
RST000-S	RST000-H	NA	000	170	13mm	8mm	3mm
RST00-S	RST00-H	RST00-H2	00	90	15mm	10mm	3mm
RST0-S	RST0-H	RST0-H2	0	63	17mm	13mm	3mm
RST1-S	RST1-H	RST1-H2	1	52	19mm	14mm	4mm
RST2-S	RST2-H	RST2-H2	2	45	20mm	16mm	5mm
RST3-S	RST3-H	RST3-H2	3	33	24mm	18mm	5mm
RST4-S	RST4-H	RST4-H2	4	28	26mm	20mm	5mm
RST5-S	RST5-H	RST5-H2	5	24	27mm	23mm	5mm
RST5A-S	RST5A-H	RST5A-H2	5½	21	28mm	24mm	5mm
RST6-S	RST6-H	RST6-H2	6	18	32mm	26mm	5mm
RST6A-S	RST6A-H	RST6A-H2	6½	16	34mm	27mm	5mm
RST7-S	RST7-H	RST7-H2	7	13	37mm	30mm	5mm
RST7A-S*	RST7A-H*	RST7A-H2*	7½	13	39mm	31mm	5mm
RST8-S	RST8-H	RST8-H2	8	10	41mm	33mm	5mm
RST8A-S*	RST8A-H*	RST8A-H2*	8½	10	43mm	36mm	5mm
RST9-S	RST9-H	RST9-H2	9	9	45mm	37mm	5mm
RST9A-S*	RST9A-H*	RST9A-H2*	9½	9	46mm	38mm	5mm
RST10-S	RST10-H	RST10-H2	10	7	50mm	42mm	5mm
RST10A-S	RST10A-H	RST10A-H2	10½	7	53mm	45mm	5mm
RST11-S	RST11-H	RST11-H2	11	6	56mm	48mm	5mm
RST11A-S	RST11A-H	RST11A-H2	11½	6	63mm	50mm	5mm
RST12-S*	RST12-H*	RST12-H2*	12	5	64mm	54mm	5mm
RST13-S*	RST13-H*	RST13-H2*	13	4	68mm	58mm	5mm
RST14-S*	RST14-H*	RST14-H2*	14	1	90mm	75mm	5mm
RST15-S*	RST15-H*	RST15-H2*	15	1	103mm	83mm	5mm
RST16-S*	RST16-H*	RST16-H2*	16	1	127mm	90mm	5mm



Rubber Stopper Assortments

These black stoppers are made of solid natural rubber that stays pliable over a long period of time. Ideal for use with non-aggressive or concentrated solutions. Low sulfur content. Withstand temperatures from -25 to 70°C (-13 to 158°F).

These convenient assortments of various sizes of rubber stoppers are sold as one-pound bags.

Item No.	Description	Sizes
RSTPK1	Rubber Stoppers, Assorted, one pound	1 to 6
RSTPK2	Rubber Stoppers, Solid, one pound	00 to 7
RSTPK3	Rubber Stoppers, 1-Hole, one pound	00 to 7
RSTPK4	Rubber Stoppers, 2-Hole, one pound	2 to 8



Cork Borer Sets

Good quality plated brass cork borers with solid brass handles, except for Set of 3 which includes plastic handles.

Item No.	Description
CBST03	Cork Borers, Set of 3
CBST06	Cork Borers, Set of 6
CBST09	Cork Borers, Set of 9
CBST12	Cork Borers, Set of 12



Neoprene Stoppers

Neoprene stoppers can be used in areas where rubber would be attacked by reagents or solvents. Synthetic green neoprene stoppers have good resiliency and shelf-life. They withstand petroleum products and oils as well as most inorganic acids and bases. Sold as one-pound bags.



Item No. Solid	Item No. One-Hole	Item No. Two-Hole	Stopper Size	Approx. No. per Lb.	Top Diameter	Bottom Diameter	Hole Size
NST000-S	NST000-H	NA	000	160	13mm	8mm	3mm
NST00-S	NST00-H	NST00-H2	00	95	15mm	10mm	3mm
NST0-S	NST0-H	NST0-H2	0	68	17mm	13mm	3mm
NST1-S	NST1-H	NST1-H2	1	57	19mm	14mm	4mm
NST2-S	NST2-H	NST2-H2	2	48	20mm	16mm	5mm
NST3-S	NST3-H	NST3-H2	3	35	24mm	18mm	5mm
NST4-S	NST4-H	NST4-H2	4	30	26mm	20mm	5mm
NST5-S	NST5-H	NST5-H2	5	25	27mm	23mm	5mm
NST5A-S	NST5A-H	NST5A-H2	5½	21	28mm	24mm	5mm
NST6-S	NST6-H	NST6-H2	6	19	32mm	26mm	5mm
NST6A-S	NST6A-H	NST6A-H2	6½	16	34mm	27mm	5mm
NST7-S	NST7-H	NST7-H2	7	14	37mm	30mm	5mm
NST8-S	NST8-H	NST8-H2	8	12	41mm	33mm	5mm
NST9-S	NST9-H	NST9-H2	9	10	45mm	37mm	5mm
NST10-S	NST10-H	NST10-H2	10	8	50mm	42mm	5mm
NST10A-S	NST10A-H	NST10A-H2	10½	7	53mm	45mm	5mm
NST11-S	NST11-H	NST11-H2	11	6	56mm	48mm	5mm
NST11A-S	NST11A-H	NST11A-H2	11½	6	63mm	50mm	5mm
NST12-S	NST12-H	NST12-H2	12	5	64mm	54mm	5mm
NST13-S	NST13-H	NST13-H2	13	4	68mm	58mm	5mm
NSTPK2	Neoprene Stopper Assortment, One Pound						



NSTPK2



Cork Stoppers

These grade XXX tapered cork stoppers are an excellent choice for general laboratory use. They are effective for both liquid and solid mediums, and offer light weight, resilience and compressibility. Chemically inert and moisture resistant. Sold as packs of 100.

Item No.	Stopper Size	Height	Top Diameter	Bottom Diameter	Quantity per pack
CST000	000	13mm	6mm	4mm	100
CST00	00	13mm	8mm	5mm	100
CST0	0	13mm	10mm	7mm	100
CST1	1	16mm	11mm	8mm	100
CST2	2	17mm	13mm	9mm	100
CST3	3	19mm	14mm	10mm	100
CST4	4	20mm	16mm	11mm	100
CST5	5	22mm	17mm	12mm	100
CST6	6	24mm	19mm	13mm	100
CST7	7	25mm	21mm	15mm	100
CST8	8	27mm	22mm	17mm	100
CST9	9	29mm	24mm	18mm	100
CST10	10	31mm	25mm	20mm	100
CST11	11	31mm	27mm	21mm	100
CST12	12	31mm	29mm	22mm	100
CST13	13	31mm	30mm	24mm	100
CST14	14	31mm	32mm	25mm	100
CST15	15	31mm	33mm	27mm	100
CST16	16	38mm	35mm	27mm	100
CST17	17	38mm	36mm	30mm	100
CST18	18	38mm	38mm	31mm	100
CST19	19	38mm	40mm	33mm	100
CST20	20	38mm	41mm	34mm	100



Test Tube Brushes, Natural Bristles

Good quality natural bristles mounted in twisted heavy gauge galvanized wire. All brushes feature a radial top.

Additional sizes are available. Please call for details.

Item No.	Brush Length	Brush Diameter	Overall Length	Quantity per pack
TTBN01	3"	1/2"	8"	12
TTBN02	3"	3/4"	8"	12
TTBN03	3"	1"	9"	12
TTBN04	4"	1-1/2"	11"	12



Test Tube Brushes, Nylon Bristles

Good quality nylon bristles mounted in twisted heavy gauge galvanized wire. All brushes feature a radial top.

Additional sizes are available. Please call for details.

Item No.	Brush Length	Brush Diameter	Overall Length	Quantity per pack
TTBRB1	3"	1/2"	8"	12
TTBRB2	3"	3/4"	8"	12
TTBRB3	3"	1"	9"	12
TTBRB4	4"	1-1/2"	11"	12



Test Tubes, Polystyrene with Cap

This 13 x 100mm polystyrene test tube has a capacity of 7ml. Tube features a round bottom and includes a hollow top plug cap made of polypropylene. Sold as a pack of 100 tubes.

Item No.	Description
TPSC131	Test Tube, Polystyrene with Cap, pack of 100

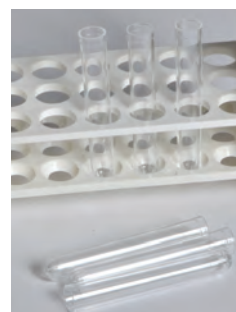

Test Tubes, Polypropylene

This 12 x 75mm polypropylene test tube has a capacity of 5ml. Tube features a round bottom and is autoclavable. Sold as a pack of 100 or 250 tubes.

Item No.	Description
TPP1275	Test Tube, Polypropylene, pack of 100
TPP1275-PK/250	Test Tube, Polypropylene, pack of 250

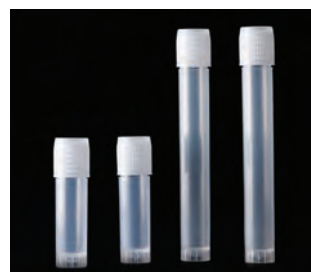

Storage Vials, PP

Storage vials are designed for use with samples from -80° to 121°C. DNase, RNase, and Pyrogen free. Used for storage of PCR reagents, enzymes and other diagnostics, biochemical reagents or samples.

Polypropylene vials feature a large white frosted labeling area, silk screen graduations, and a leak-proof HDPE cap.

Item No.	Capacity (ml)	Outside Diameter (mm)	Height (mm)	Quantity per pack
P60106	2.0	11.80	47.2	1000
P60107	5.0	11.80	88	1000



Test Tubes with Rim, Borosilicate Glass

Pre-cleaned borosilicate glass test tubes with rims. Tubes can be used for hot or cold applications, are reusable, and can be autoclaved.

Item No.	O.D. x Length (mm)	Capacity (ml)	Quantity per pack	Quantity per case
TT9800-A	10 x 75	3	72	720
TT9800-B	12 x 75	5	72	720
TT9800-C	12 x 100	8	72	720
TT9800-D	15 x 125	15	72	720
TT9800-E	15 x 150	17	72	720
TT9800-L	16 x 100	14	72	720
TT9800-M	16 x 125	16	72	720
TT9800-F	18 x 150	24	72	720
TT9800-N	20 x 150	36	72	720
TT9800-G	25 x 100	37	72	720
TT9800-H	25 x 150	60	72	288
TT9800-I	25 x 200	75	48	192
TT9800-J	32 x 200	125	50	50
TT9800-K	38 x 200	175	50	50

Test Tubes without Rim, Borosilicate Glass

Pre-cleaned borosilicate glass test tubes without rims. Tubes can be used for hot or cold applications, are reusable, and can be autoclaved.

Item No.	O.D. x Length (mm)	Capacity (ml)	Quantity per pack	Quantity per case
TT9820-A	10 x 75	3	72	720
TT9820-B	12 x 75	5	72	720
TT9820-C	12 x 100	8	72	720
TT9820-D	15 x 125	15	72	720
TT9820-E	15 x 150	17	72	720
TT9820-F	16 x 100	14	72	720
TT9820-G	18 x 150	24	72	720
TT9820-H	25 x 100	37	72	720
TT9820-I	25 x 150	60	72	288
TT9820-J	25 x 200	75	48	192
TT9820-K	32 x 200	125	50	50
TT9820-L	38 x 200	175	50	50

Disposable Culture Tubes, Borosilicate

Disposable culture tubes are manufactured from high quality borosilicate glass. Rimless design enables easy plugging using a stopper. Caps not included. Tubes meet ASTM standards and are alkali-free and inert.



Item No.	O.D. x Length (mm)	Capacity (ml)	Quantity per pack	Quantity per case
TT9920-B	12 x 75	5	72	720
TT9920-C	13 x 100	9	72	720
TT9920-F	16 x 100	11	72	720
TT9920-M	16 x 125	15	72	720
TT9920-E	16 x 150	20	72	720
TT9920-G	18 x 150	27	72	720
TT9920-N	20 x 150	34	72	720
TT9920-I	25 x 150	55	72	288
TT9920-J	25 x 200	75	48	192

Culture Tubes with Cap, Round Bottom

Tubes with round bottoms are manufactured from ASTM E438 Type 1 Class A Borosilicate 3.3 glass. Includes polypropylene autoclavable screw cap with PTFE liner.

Item No.	O.D. x Length (mm)	Capacity (ml)	Quantity per pack	Quantity per case
TT9900-5	16 x 50	5	10	100
TT9900-10	25 x 50	10	10	100
TT9900-30	25 x 95	30	20	100
TT9900-60	25 x 200	60	20	100



Wire Stripper

Quickly removes insulation without damaging wire. Set-screw adjusts stripper to fit wire gauges from 10 to 24. Made from drop-forged, heat-treated steel with black baked enamel finish. PVC handles. Total length is 4 inches.

Item No.	Description
WSTK01	Wire Stripper



General Tools Kit

Consists of 6" slip joint pliers, 6.5" long nose pliers, 6" adjustable wrench, 3-piece offset screwdriver set, and a 6-in-1 screwdriver set featuring slotted bits, Phillips bits, and nut drivers.

Item No.	Description
TKIT04	General Tools Kit of 7



Screwdriver

Slotted screwdrivers with durable plastic handle. Available in two different head sizes.

Item No.	Description
SDR001	Screwdriver, 120mm long x 2mm head
SDR002	Screwdriver, 110mm long x 4mm head



Triangular Files

Triangular file has a tapered shape, and is mounted on a hardwood handle for easy gripping. For general laboratory use, including to score glass before cutting.

Item No.	Description	Overall Length
TRF004	4" Triangular File	7"
TRF005	5" Triangular File	8"
TRF006	6" Triangular File	9"
TRF008	8" Triangular File	11"



NEW PRODUCT

Flashlight, LED

Plastic 6" long flashlight includes long-lasting LED illumination and lanyard. Uses two AA batteries (not included). Plastic case color may vary.

Item No.	Description
FSLT03-C	Flashlight, LED



Ultraviolet Light

This high-quality 6", 4W handheld blacklight is ideal for forensics or illuminating fluorescent and blacklight reactive items. Also includes a built-in LED flashlight. Requires 4 AA batteries (not included).

Item No.	Description
AISUVLT1	Ultraviolet Light



Instrument Trays, PP

Handy for storage and sterilization of instruments, these durable polypropylene trays include covers that fit snugly into grooves molded into the trays. Available in two sizes: the smaller size can be used to sterilize small instruments, and the large size allows pipettes to be fully immersed in disinfectant before sterilization. Autoclavable.

Item No.	Description	Quantity per pack
81736	Instrument Tray, 22cm x 15cm x 7cm	2
81737	Instrument Tray, 45cm x 15cm x 7cm	2



Laboratory Trays, Large, PP

Large polypropylene molded laboratory tray is steam autoclavable and can be used for sterilizing and drying labware. The 5" depth makes this tray ideal for storage of labware

Item No.	Description	Quantity per pack
81722	Laboratory Tray, Large , PP, 20" x 17" x 5"	6



Carrier Trays, PP

Polypropylene molded carrier tray is steam autoclavable. Includes a built-in handle for easy carrying of reagent bottles or other laboratory ware using one hand. Overall depth including the handle is 6". Trays are nestable for easy storage when empty.

Item No.	Description	Quantity per pack
81731	Carrier Tray, PP, 15" x 9.5" x 4.5"	6



Utility Trays, PP

Polypropylene molded utility tray is steam autoclavable and can be used for sterilizing and drying labware. The 5" depth makes this tray ideal for storage of labware.

Item No.	Description	Quantity per pack
81721	Utility Tray, PP, 15" x 14" x 5"	6



Laboratory Trays, PP

Multi-purpose polypropylene molded trays can be used for sterilizing, drying glassware, porcelainware, and other laboratory supplies. These steam autoclavable trays have tapered walls designed for nesting.

Item No.	Description	Quantity per pack
81701	Laboratory Tray, PP, 18" x 14" x 3"	10
81702	Laboratory Tray, PP, 15" x 12" x 3"	10



Laboratory Trays, Flat, PP

Flat polypropylene laboratory trays are ideal for containing small spills, and to serve as a drip pan. Economical trays measuring 15" x 11.5" are versatile for general laboratory use. Autoclavable. Solds as packs of 10.

Item No.	Description	Quantity per pack
LTRAY1	Laboratory Tray, Flat, PP, 15" x 11.5"	10



Connectors, L-shaped, PP

Polypropylene L-shaped connectors with serrated ends are ideal for leak-proof tubing connections. Autoclavable.

Item No.	Description	Quantity per pack
46131	L-Connector, for 6mm tubing	12
46132	L-Connector, for 8mm tubing	12
46133	L-Connector, for 10mm tubing	12



Connectors, T-shaped, PP

Polypropylene T-shaped connectors with serrated ends are ideal for leak-proof tubing connections. Autoclavable.

Item No.	Description	Quantity per pack
46111	T-Connector, for 6mm tubing	12
46113	T-Connector, for 8mm tubing	12
46115	T-Connector, for 10mm tubing	12



Connectors, Y-shaped, PP

Polypropylene Y-shaped connectors with serrated ends are ideal for leak-proof tubing connections. Autoclavable.

Item No.	Description	Quantity per pack
46112	Y-Connector, for 6mm tubing	12
46114	Y-Connector, for 8mm tubing	12
46116	Y-Connector, for 10mm tubing	12



Tubing Connectors Assortment, PP

A convenient assortment pack of 36 tubing connectors for your lab, usable with a variety of tubing sizes and connections. Pack includes 9 each (3 each x 3 sizes) of L-shaped, T-shaped, Y-shaped, and 4-way polypropylene connectors that are autoclavable.

Item No.	Description
TCA002	Tubing Connectors Assortment, PP, pack of 36



Connectors, 4-way, PP

Polypropylene cross-shaped connectors with serrated ends are ideal for leak-proof tubing connections. Autoclavable.

Item No.	Description	Quantity per pack
46121	4-way Connector, for 6mm tubing	12
46122	4-way Connector, for 8mm tubing	12
46123	4-way Connector, for 10mm tubing	12



Stopcocks, PP/PTFE

These leak-proof economical polypropylene stopcocks have a PTFE plug and serrated ports that accept tubing from 6mm to 10mm in diameter. Available in 2-way and 3-way versions.

Item No.	Description	Quantity per pack
55301	Stopcock, 2-way	6
55302	Stopcock, 3-way	6



NEW



Glass Tubing, Flint

Tubing made from fine quality flint glass for easy bending, blowing, and sealing of soft glass apparatus. Tubing is 24" long and available in various diameters.

Item No.	Description
GFT005	Glass Tubing, Flint, 5mm
GFT006	Glass Tubing, Flint, 6mm
GFT007	Glass Tubing, Flint, 7mm
GFT008	Glass Tubing, Flint, 8mm

Glass Tubing Assortment

This convenient one-pound assortment of borosilicate glass tubing includes various thicknesses and wall sizes. All pieces are 12" in length.

Item No.	Description	Bore/Thickness
GBT001	Glass Tubing Assortment	Various



Rubber Tubing, General Purpose

Flexible and strong rubber available in 10' and 50' lengths. We stock red color; black is available as special order. Additional sizes as well as custom lengths are available upon request.

Item No.	Description	Bore/Thickness
RT4812-10	Rubber Tubing, Red, 10'	4.8mm/1.2mm
RT4812-50	Rubber Tubing, Red, 50'	4.8mm/1.2mm
RT6016-10	Rubber Tubing, Red, 10'	6.0mm/1.6mm
RT6016-50	Rubber Tubing, Red, 50'	6.0mm/1.6mm
RT9524-10	Rubber Tubing, Red, 10'	9.5mm/2.4mm
RT9524-50	Rubber Tubing, Red, 50'	9.5mm/2.4mm



www.unitedsci.com

United Scientific Supplies, Inc.

1001 Technology Way
Libertyville IL 60048
www.unitedsci.com

P: +1 847-336-7556
F: +1 847-336-7571
E: info@unitedsci.com